



 **GERMAN  
ENGINEERED**

# Retail Product Price Guide

PREMIUM GARAGE DOOR SOLUTIONS



*Intelligent Door Solutions*

MAY 2026



[www.novoferm.co.uk](http://www.novoferm.co.uk)

# NEW

## Stunning New Colours

Available in our Steel and Roller  
Door Ranges

PAGES 4, 22



## 3-Point Locking System

Available Across Our Steel  
Side-Hinged Door Range

PAGES 8-9

## NovoTherma

Insulated Double Side-Hinged  
and Side Personnel Doors

PAGES 8-10

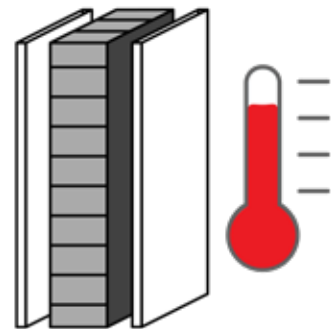

## ANSA Safety System

Available on Novorol 77 and 55  
Roller Door Range

PAGES 22-23

## Secured by Design

Now Available On Our 77  
Roller Door Range

PAGE 23



# Contents

## STEEL GARAGE DOORS

Steel colours, finishes & styles	4-5
Steel up & over single doors	6
Steel up & over double doors	7
Steel side-hinged styles & doors	8-9
Steel side personnel doors	10-11
Steel side gates	12-13

## SECTIONAL GARAGE DOORS

ISO20 sectional textures, colours, styles & garage doors	14-15
ISO45 sectional textures, colours & styles	16-17
ISO45 sectional garage doors	18-19
Insulated ISO45 wicket doors	20
ISO EVO matching side doors	21

## ROLLER GARAGE DOORS

Novorol colours & finishes	22
Novorol 77 & 55 doors	23

## TIMBER GARAGE DOORS

Timber colours & finishes	24
Timber up & over door styles	25
Timber up & over single doors	26
Timber up & over double doors	27
Timber side-hinged door styles	28
Timber side-hinged doors	29
Timber side personnel doors	29

## GRP GARAGE DOORS

GRP colours, finishes & styles	30-31
GRP up and over single doors	32
GRP up and over double doors	33-34

## OPERATORS & ACCESSORIES

Garage door operators & accessories	35-38
-------------------------------------	-------

## TECHNICAL GUIDES AND INFORMATION

Technical guides and information	39-58
Warranty information	59

## Colours & Finishes

### Essential Colours



TRAFFIC WHITE RAL 9016



JET BLACK RAL 9005



ANTHRACITE GREY RAL 7016



**Bespoke Colours**

RAL colours available on request

### Premium Colours



PURE WHITE RAL 9010



CREAM RAL 9001



CLAY STONE RAL 080.80.05



LIGHT GREY RAL 7035



AGATE GREY RAL 7038



STONE GREY RAL 7030



SIGNAL GREY RAL 7004



WINDOW GREY RAL 7040



SILVER GREY RAL 7001



SLATE GREY RAL 7015



BLACK BROWN RAL 8022



PEBBLE GREY RAL 7032



CHARTWELL GREEN BS14C35



SAGE NCS 4005-G80Y



FIR GREEN RAL 6009



MOSS GREEN RAL 6005



DUCK EGG RAL 260.80.10



BRILLIANT BLUE RAL 5007



STEEL BLUE RAL 5011



COBALT BLUE RAL 5013



CLAY BROWN RAL 8003



CHERRY BROWN CHROMA 3353



CHOCOLATE BROWN RAL 8017



RUBY RED RAL 3003



BROWN RED RAL 3011

### Timber Effect

Choose from 2 high grade Timber Effect laminate finishes.

\*Available in some designs only, please check with your installer. All colour samples depicted in this brochure are as close to the original manufacturer's colours as possible. Rivets are visible on the face of the door in some door styles and all Timber Effect laminated doors.



Steel Side Gates are not available in Timber Effect



Matching hinge available in this colour



GOLDEN OAK



ROSEWOOD



Garage doors supplied may vary in colour from the brochure representation.

## Styles

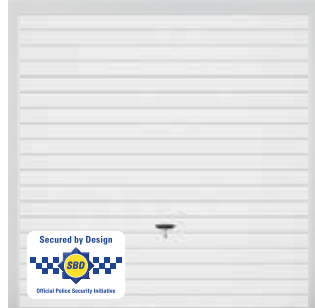

Vertical  



Horizontal  

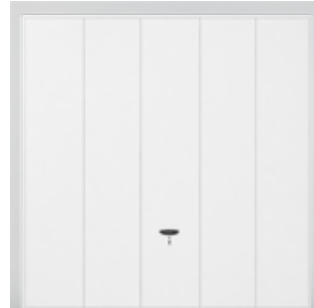

Venus  





Victor  



Helios  





Horsham  



Berkeley Vertical  



Wentworth  





Regency  



Georgian





Minster  



Berwick  





Regency Glazed  



Georgian Glazed



Handles are black as standard

 = Available in Rosewood  
 = Available in Golden Oak  
 = Available in Secured By Design

 **Please note:** Vertical centre panel inserted on Helios door panel over 2496mm wide and Horsham door panel over 2438mm wide.

# Steel Up & Over Garage Doors

## Single Doors (Frame Included)

	Up-to Door Panel Size (W x H)		Vertical & Horizontal	Venus, Victor, Helios & Horsham	Regency, Georgian & Minster (Max Height 2134)	Berkeley Vertical & Wentworth	Regency & Georgian Glazed	Berwick
	Imperial	Metric						
	7'0" x 6'6"	2134 x 1981	£1196	£1466	£1514	£1640	£1782	£1958
	7.0" x 7.0"	2134 x 2134	£1270	£1535	£1582	£1709	£1850	£1995
	7.0" x 7.6"	2134 x 2286	£1421	£1628	-	£1804	-	£2007
	7.6" x 6.6"	2286 x 1981	£1329	£1635	£1656	£1810	£1924	£2053
	7.6" x 7.0"	2286 x 2134	£1466	£1773	£1783	£1947	£2051	£2074
	7.6" x 7.6"	2286 x 2286	£1559	£1851	-	£2026	-	£2084
	8'0" x 6'6"	2438 x 1981	£1492	£1883	£1984	£2058	£2320	£2138
	8'0" x 7'0"	2438 x 2134	£1535	£1905	£1984	£2116	£2320	£2159
	8'0" x 7.6"	2438 x 2286	£1687	£1994	-	£2170	-	£2161
	9'0" x 6'6"	2743 x 1981	£1857	£2053	£2084	£2228	£2419	-
	9'0" x 7'0"	2743 x 2134	£2016	£2180	£2202	£2355	£2537	-
	9'0" x 7.6"	2743 x 2286	£2069	£2244	£2253	£2419	£2588	-

For Made To Measure use next size up

**Only available as Retractable**

	Vertical, Horizontal, Venus, Victor, Horsham & Helios		Regency, Regency Glazed & Minster		Georgian & Georgian Glazed		Berkeley Vertical & Wentworth		Berwick	
	Canopy	Retractable	Canopy	Retractable	Canopy	Retractable	Canopy	Retractable	Canopy	Retractable
Minimum Width	1956	1981	1956	1981	1956	1981	1956	1981	1956	1981
Maximum Width	2438	2743	2438	2743	2438	2743	2438	2743	2438	2743
Minimum Height	1829	1860	1886	1886	1914	1914	1829	1860	1829	1860
Maximum Height	2134	2286	2134	2134	2134	2155	2134	2286	2134	2286
For <b>Canopy</b> overframe width	<b>+108mm Total</b>									
For <b>Retractable</b> overframe width	<b>+140mm Total</b>									
For <b>Overframe</b> height on all doors	<b>+45mm Total</b>									

**Product over 2134mm high only available as retractable**

Colour Information	
Essential Colours	£ Incl.
Premium Colours	£220
Timber Effect	£500
Bespoke Colours	POA
Standard frame colour is white - Matching frame available FOC. Timber Effect frame - finished in nearest complementary RAL Colour.	£ Incl.

Locking & Security Information	
	£ Incl.
	All products are supplied with 4-Point Slam latching as standard
	4-Point locking (Locking bar) £129
	Upgrade to Secured By Design** Available in Retractable and selected designs only. Please see page 5. £475

Automation Prices applied when order in combination with door - For operator only see page 35	
Novomatic 443	£440
Novomatic 573S	£520
De-latching Kit for Novoferm Retractable Doors	£206
Homematic Smart Home Kit	£154

**Please note:** All doors come with lock hole and handle unless otherwise requested.

Window Frame Colour Information	
	£ Incl.
Standard frame colour is white. Matching frame available FOC	
Timber Effect window frame - finished in nearest complementary RAL Colour.	£ Incl.

\* For further information on automation please see pages 35-36.

Glazing Options		
Clear	Stippled	Black
£ Incl.	£ Incl.	£ Incl.

Leading Options (prices are per door)		
Diamond Lattice	Square Lattice	Queen Anne Lattice
£100	£100	£100

All prices are exclusive of VAT.

For technical information on this product please refer to pages 40-46.

## Double Doors - Retractable Only (Frame Included)

	Up-to Door Panel Size (W x H)		Vertical & Horizontal	Venus	Berkeley Vertical	Regency, Georgian & Minster (Max Height 2134)	Regency & Georgian Glazed	Berwick
	Imperial	Metric						
£	10'0" x 7'0"	3048 x 2134	£2440	£2623	£2758	£2652	£2984	£3183
	10'0" x 7'6"	3048 x 2286	£2494	£2655	£2812	-	-	-
	11'0" x 7'0"	3353 x 2134	£2546	£2710	£2864	£2758	£3146	£3289
	11'0" x 7'6"	3353 x 2286	£2600	£2765	£2918	-	-	-
	12'0" x 7'0"	3658 x 2134	£2652	£2820	£2971	£2864	£3252	£3395
	12'0" x 7'6"	3658 x 2286	£2706	£2875	£3024	-	-	-
	13'0" x 7'0"	3962 x 2134	£2758	£2930	£3077	£2971	£3414	-
	13'0" x 7'6"	3962 x 2286	£2812	£2930	£3130	-	-	-
	14'0" x 7'0"	4267 x 2134	£2864	£2985	£3183	£3077	£3520	£3501
	14'0" x 7'6"	4267 x 2286	£2918	£3040	£3236	-	-	-
	15'0" x 7'0"	4572 x 2134	£2971	-	-	-	-	-
	15'0" x 7'6"	4572 x 2286	£3024	-	-	-	-	-
	16'0" x 7'0"	4877 x 2134	£3077	-	-	-	-	-
	16'0" x 7'6"	4877 x 2286	£3130	-	-	-	-	-

Only available as Retractable

	Door Operation	Vertical & Horizontal	Venus	Berkeley Vertical	Regency, Regency Glazed & Minster	Georgian & Georgian Glazed	Berwick
	Minimum Width	2744	2744	2744	2744	2744	3048
	Maximum Width	4877	4877	4877	4877	4877	4267
	Minimum Height	1905	1905	1905	1905	1930	1905
	Maximum Height	2286	2286	2286	2286	2134	2134
	For Retractable overframe width	+140mm Total					
	For Overframe height on all doors	+68mm Total					

Colour Information		
	Essential Colours	£ Incl.
	Premium Colours	£380
	Timber Effect	£875
	Bespoke Colours	POA
	Standard frame colour is white - Matching frame available FOC. Timber Effect frame - finished in nearest complementary RAL Colour.	£ Incl.

Locking Information		
	3-point locking as standard	£ Incl.



 **Please note:** All doors come with lock hole and handle unless otherwise requested.

Window Frame Colour Information		
	Standard frame colour is white. Matching frame available FOC	£ Incl.
	Timber Effect window frame - finished in nearest complementary RAL Colour.	£ Incl.

Automation Prices applied when order in combination with door - For operator only see page 35		
	Novomatic 443	£440
	Novomatic 573S	£520
	Homematic Smart Home Kit	£154

\* For further information on automation please see pages 35-36.

Glazing Options		
		
Clear	Stippled	Black
£ Incl.	£ Incl.	£ Incl.

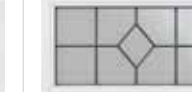
Leading Options (prices are per door)		
		
Diamond Lattice	Square Lattice	Queen Anne Lattice
£160	£160	£160



All prices are exclusive of VAT.

 For technical information on this product please refer to pages 40-46.

# Steel Side-Hinged Garage Doors

## Styles



-  = Available in Rosewood
-  = Available in Golden Oak

 = Door style available with Insulated NovoTherma

 = Please note that the rear of all NovoTherma Insulated doors will be finished in white

**The large leaf can be the lead door. Please see the opening options (viewed from outside) below:**

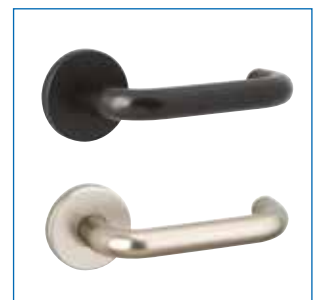
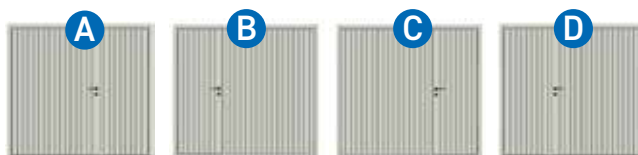

- A 2/3-1/3 Left Hand Opening
- B 1/3-2/3 Left Hand Opening
- C 2/3-1/3 Right Hand Opening
- D 1/3-2/3 Right Hand Opening



Side-Hinged handles are available in black and silver

# Steel Side-Hinged Garage Doors

£	Up-to Door Panel Size (W x H)		Vertical	Venus, Victor & Horsham	Regency & Georgian (Max Height 2134)	Regency Glazed & Georgian Glazed	Berkeley Vertical, Berkeley Horizontal & Wentworth	Berwick
	Imperial	Metric						
	7'0" x 7'0"	2134 x 2134	£2055	£2163	£2471	£2739	£2487	2596
7'0" x 7'6"	2134 x 2286	£2109	£2218	-	-	£2596	2704	
7'6" x 7'0"	2286 x 2134	£2163	£2271	£2569	£2837	£2704	2812	
7'6" x 7'6"	2286 x 2286	£2218	£2326	-	-	£2812	2920	
8'0" x 7'0"	2438 x 2134	£2271	£2379	£2660	£2928	£2920	3028	
8'0" x 7'6"	2438 x 2286	£2326	£2434	-	-	£3028	3136	

	Door Operation	Vertical, Horizontal, Venus, Victor & Horsham	Regency & Regency Glazed	Georgian & Georgian Glazed	Berkeley Vertical, Berkeley Horizontal, & Wentworth	Berwick
	Minimum Width	1750	1839	1998	1750	2083
	Maximum Width	2438	2438	2438	2438	2438
	Minimum Height	1775	1868	1912	1775	1775
	Maximum Height	2286	2134	2155	2286	2286
For <b>overframe</b> width			<b>+100mm Total</b>		 For Made To Measure use next size up	
For <b>overframe</b> height			<b>+50mm Total</b>			

	Door Format				
	1/2 - 1/2 (Split)	Vertical, Horsham & Venus	Regency	Berkeley Vertical/Horizontal	Berwick Glazed
	2/3 - 1/3 (Split)	Vertical	Georgian		

 Please refer to door styles page for door opening format options. When ordering please state option required. Vertical 2/3 - 1/3 split not available in NovoTherma.

	Door Hinges	
	Doors are hinged outward as standard - for inward opening (not available with colour match hinges) +	<b>£103</b>
	When ordering please state "Lead Door" as viewed from outside (VFO) Matching hinges are available in some colours - please refer to finishes page for details	

	Colour Information	
	Essential Colours	<b>£ Incl.</b>
	Premium Colours	<b>£220</b>
	Timber Effect	<b>£500</b>
	Bespoke Colours	<b>POA</b>
	Standard frame colour is white - Matching frame available FOC. Timber Effect frame - finished in nearest complementary RAL Colour.	<b>£ Incl.</b>

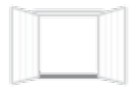

	Threshold	
	Optional Threshold (for use with standard single-point locking)	<b>£75</b>

	Handles Colour Options	
	Black	<b>£ Incl.</b>
	Brush Silver	<b>£ Incl.</b>

	Window Frame Colour Information	
	Standard frame colour is white. Matching frame available FOC.	<b>£ Incl.</b>
	Timber Effect window frame - finished in nearest complementary RAL Colour.	<b>£ Incl.</b>

	Locking Information	
	Thumb Turn Cylinder Lock	<b>£55</b>
	3-point locking (including threshold)	<b>£249</b>

Glazing Options		
		
Clear	Stippled	Black
<b>£ Incl.</b>	<b>£ Incl.</b>	<b>£ Incl.</b>

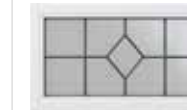
Leading Options (prices are per door)		
		
Diamond Lattice	Square Lattice	Queen Anne Lattice
<b>£100</b>	<b>£100</b>	<b>£100</b>

All prices are exclusive of VAT.  For technical information on this product please refer to pages 47-48.



## NEW NOVOTherma

### Insulated Double Steel Side-Hinged Garage Doors

 Excludes glazed designs - see styles page for further details

ADD

# £499

TO YOUR STANDARD DOOR PRICE

3-POINT LOCKING & THRESHOLD INCLUDED

## Styles



Vertical   



Horizontal   



Berkeley Vertical   



Helios   



Horsham   



Venus   



Victor   



Regency   





Georgian 





Regency Glazed  



Georgian Glazed  

-  = Available in Rosewood
-  = Available in Golden Oak

 = Available with Insulated NovoTherma.  
NovoTherma not available with Glazed options.

 Please note that the rear of all NovoTherma Insulated doors will be finished in white



Side Door handles are available in black and silver

# Steel Side Personnel Doors

£	Sizing mm (W x H)	Vertical & Horizontal	Helios, Horsham, Venus & Victor	Regency, Georgian (Max Height 2155)	Regency Glazed & Georgian Glazed (Max Height 2155)	Berkeley Vertical
	689-1219 x 1868-2286	£1125	£1283	£1305	£1372	£1517

Additional Size Information	
For overframe width	+100mm Total
For overframe height	+50mm Total

Door Hinges	
Doors are hinged outward as standard - for inward opening +	£62
When ordering please state "Hinge Handing" as viewed from outside (VFO)	
Matching hinges are available in some colours - please refer to colour page for details	

Colour Information	
Essential Colours	£ Incl.
Premium Colours	£150
Timber Effect	£300
Bespoke Colours	POA
Standard frame colour is white - Matching frame available FOC. Timber Effect frame - finished in nearest complementary RAL Colour.	£ Incl.

Thresholds	
Optional Threshold (for use with standard single-point locking)	£50

Locking Information	
Thumb Turn Cylinder Lock	£55
Door Stays	£83
3-point locking (includes threshold)	£224

Handles Colour Options	
Black	£ Incl.
Brush Silver	£ Incl.

Window Frame Colour Information	
Standard frame colour is white. Matching frame available FOC.	£ Incl.
Timber Effect window frame - finished in nearest complementary RAL Colour.	£ Incl.

Glazing Options		
		
Clear	Stippled	Black
£ Incl.	£ Incl.	£ Incl.

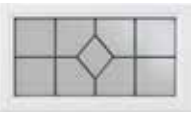
Leading Options (prices are per door)		
		
Diamond Lattice	Square Lattice	Queen Anne Lattice
£45	£45	£45



## NEW! NOVOTherma

### Insulated Steel Side Personnel Doors

ADD

# £349

TO YOUR STANDARD DOOR PRICE

3-POINT LOCKING & THRESHOLD INCLUDED

All prices are exclusive of VAT.

 For technical information on this product please refer to page 49.

## Finishes & Colours

### Finishes



SMOOTH

### Essential Colours



TRAFFIC WHITE RAL 9016



JET BLACK RAL 9005



ANTHRACITE GREY RAL 7016

### Premium Colours

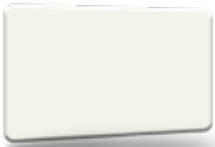

PURE WHITE RAL 9010



CREAM RAL 9001



CLAY STONE RAL 080.80.05



LIGHT GREY RAL 7035



AGATE GREY RAL 7038



STONE GREY RAL 7030



SIGNAL GREY RAL 7004



WINDOW GREY RAL 7040



SILVER GREY RAL 7001



SLATE GREY RAL 7015



BLACK BROWN RAL 8022



PEBBLE GREY RAL 7032



CHARTWELL GREEN BS14C35



SAGE NCS 4005-G80Y



FIR GREEN RAL 6009



MOSS GREEN RAL 6005



DUCK EGG RAL 260.80.10



BRILLIANT BLUE RAL 5007



COBALT BLUE RAL 5013



STEEL BLUE RAL 5011



CLAY BROWN RAL 8003



CHERRY BROWN CHROMA 3353



CHOCOLATE BROWN RAL 8017



RUBY RED RAL 3003



BROWN RED RAL 3011



### Bespoke Colours

RAL colours available on request

Garage doors supplied may vary in colour from the brochure representation.

## Styles



Vertical



Horizontal

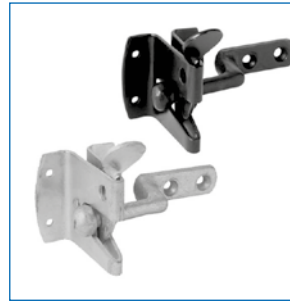

Gate Latch



Mortice Lock

£	Sizing mm (W x H)		Vertical & Horizontal
	900 - 1250 x 901 - 1200		£900
	900 - 1250 x 1201 - 1600		£950
	900 - 1250 x 1601 - 2100		£1000

Colour Swatch	Colour Information	
	Essential Colours	£ Incl.
	Premium Colours	£100
	Bespoke Colours	POA

Hinge Swatch	Hinge Colour Options	
	Black	£ Incl.
	Brush Silver	£ Incl.
	<b>Please Note:</b> When ordering please state "Hinge Handing" as viewed from outside	

Handle Swatch	Handles Colour Options	
	Black	£ Incl.
	Brush Silver	£ Incl.

Lock Swatch	Locking Information	
	1200mm high gates will be supplied with a gate latch as standard	£ Incl.
	Gates over 1200mm will be supplied with a mortice lock as standard	£ Incl.

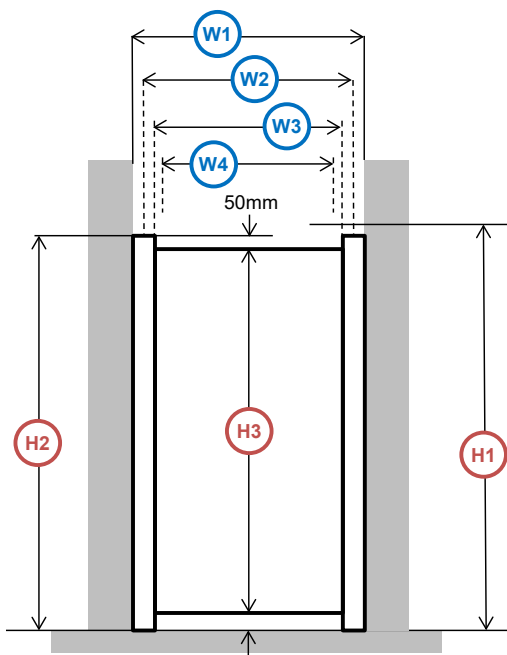

Tape Measure Icon	Additional Size Information	
	These gates are ordered either by <b>Structural Opening (SO)</b> or <b>Over Frame Size (OFS)</b> .	
	W1 = Structural Opening (SO) = <b>Maximum Frame Width</b> W2 = Over Frame Size (OFS) = <b>SO - 15mm</b> W3 = Minimum Over Frame Opening Width = <b>SO - 30mm</b> <b>Note: The Frame Leg Width is adjustable by 15mm each side.</b> W4 = Gate Leaf Width = <b>OFS - 85mm</b> <b>Note: Gates are provided with installation posts (61mm width).</b>	

H1 = Structural Size (SO) = <b>OFS + 5MM</b>
H2 = Over Frame Size (OFS) = <b>Frame Leg Height</b>
H3 = Gate Leaf Height = <b>OFS - 100mm</b>

All prices are exclusive of VAT.

## Textures & Colours

### Textures



WOODGRAIN



SMOOTH



### Essential Colours



TRAFFIC WHITE RAL 9016



ANTHRACITE GREY RAL 7016



JET BLACK RAL 9005

## Styles

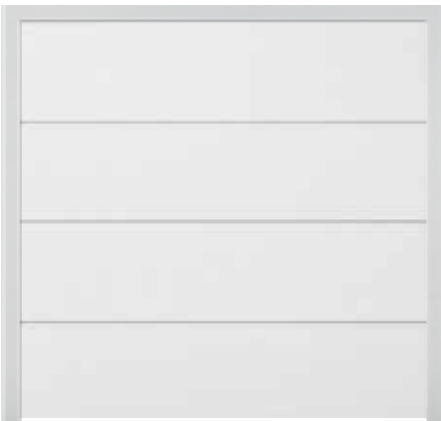

Flush | ISO20



Large Rib | ISO20



Georgian Panelled | ISO20



Available in Woodgrain texture







Available in Smooth texture

## Styles

£	Door Style	Up to Width (mm)				
	All Door Styles	Up to Height (mm)		2134	2286	2500
2125			£1288	£1323	£1380	£1471
2250			£1351	£1388	£1447	£1750
2500			£1418	£1457	£1520	£1837
2750			£1580	£1639	£1912	£1969

	Flush Smooth				Large Rib & Flush Woodgrain			
	Min Width	Max Width	Min Height	Max Height	Min Width	Max Width	Min Height	Max Height
	1800	3000	1800	2750	1800	2750	1800	2750

	Georgian Panelled Woodgrain				 Georgian Panelled products are unavailable in some heights. Please see our Sectional Door Panel Chart on page 50 for further information.  For bespoke heights, please note that door heights are only available in 25mm increments.
	Min Width	Max Width	Min Height	Max Height	
	2000	3000	1800	2750	

	Extras	
	Inbetween Fixing Kit	£100
	Frame Leg Cover Profiles 50mm (Pair) - Essential Colours	£135
	Frame Leg Cover Profiles 85mm (Pair) - Essential Colours	£135

	Colour Information	
	Essential Colours	£ Incl
	Matching colour frame Head Included	£ Incl

	Spring Mechanism	
	Tension springs supplied with all ISO20 products up to and including 3000mm wide	

	Automation Prices applied when order in combination with door - For operator only see page 35	
	Novomatic 443	£440
	Novomatic 573s	£520
	Novoport Speed	£484
	Homematic Smart Home Module	£154

	Locking Information	
	Manual locking with black D Handle	£109

All prices are exclusive of VAT.

 For technical information on this product please refer to pages 50-55.

## Textures & Colours

### Textures



### Essential Colours



### Premium Colours



### Timber Effect

Our insulated sectional garage doors are available with 5 different weather-resistant, top-coated film laminates in authentic, rustic wood effects with a smooth surface. In addition to the large rib pattern, you can now also order all the wood effects in the flush and some in the panel pattern.



 Timber Effects are only available in Smooth Texture.

## Styles



Flush | ISO45   







Large Rib | ISO45   



Horizontal Rib | ISO45  



Georgian Panelled | ISO45 

-  Available in Smooth texture
-  Available in Finegrain texture
-  Available in Woodgrain texture

## Glazed Options



Light Strip | ISO45



Horizontally or Vertically Glazed V1-V4S | ISO45





Vertically Glazed V8-V9 | ISO45

# ISO45 Sectional Garage Doors

£	Door Style	Up to Height (mm)	Up to Width (mm)									
			2134	2286	2500	3000	3500	4000	4267	4500	5000	5500
All Door Styles		2125	£1580	£1623	£1693	£2082	£2654	£2750	£2911	£3119	£3447	£3387
		2250	£1841	£1891	£1972	£2350	£2887	£2982	£3132	£3356	£3759	£3698
		2500	£1933	£1986	£2071	£2468	£3031	£3131	£3288	£3523	£3947	£3883
		3125	£2819	£2896	£3020	£3282	£3541	£3642	£3891	£4169	£4628	£4473

 Some door styles are unavailable in these sizes - please be sure to check the below size chart for further details.

	Flush Smooth				Large Rib Smooth			
	Min Width	Max Width	Min Height	Max Height	Min Width	Max Width	Min Height	Max Height
	1800	5500	1800	2500	1800	5500	1800	2500
	1800	4000	1800	3125	1800	3750	1800	3125

	Horizontal, Large Rib & Flush Woodgrain				Georgian Panelled Woodgrain			
	Min Width	Max Width	Min Height	Max Height	Min Width	Max Width	Min Height	Max Height
	1800	5500	1800	2750	2000	5000	1800	3125
	1800	5250	1800	3125	-	-	-	-

	Extras	
	Inbetween Fixing Kit	£100
	Frame Leg Cover Profiles 50mm (Pair) - Essential Colours	£135
	Frame Leg Cover Profiles 85mm (Pair) - Essential Colours	£135
	Frame Leg Cover Profiles 50mm (Pair) - Premium & Bespoke Colours	£206
Frame Leg Cover Profiles 80mm (Pair) - Premium & Bespoke Colours	£206	

 Georgian Panelled products are unavailable in some heights. Please see our Sectional Door Panel Chart on page 50 for further information.

 For bespoke heights, please note that door heights are only available in 25mm increments.

	Spring Mechanism	
	Tension springs supplied with product up to and including 3000mm wide	
	Torsion spring supplied with product over 3000mm wide	
	Torsion spring supplied with products of all widths over 2750mm high	
Low Headroom Kit (Rear Mounting Kit)	£227	

	Colour Information	
	Essential Colours	£ Incl.
	Premium Colours, Finegrain & Timber Effect Finishes up to & including 3000mm	£365
	Premium Colours, Finegrain & Timber Effect Finishes over 3000mm	£665
	Special RAL Colours up to & including 3000mm	£725
	Special RAL Colours over 3000mm	£1455
Bespoke Colours	POA	
Matching colour frame Head Included	£ Incl.	

	Locking Information	
	Manual locking with black D Handle	£109

	Automation Prices applied when order in combination with door - For operator only see page 35	
	Novomatic 443	£440
	Novomatic 573s	£520
	Novoport Speed	£484
	Homematic Smart Home Module	£154

# ISO45 Sectional Garage Doors

## Glazing Styles

				
V1 - Plain	V2 - Rhombus	V3 - Cross	V4D - Diamond Leaded	V4S - Square Leaded

V1 - V4S Standard Horizontal Window Configuration								
	Horizontal Rib, Large Rib & Flush	Up To Door Panel Widths (mm)	2000-2370	2371-2949	2950-3529	3530 -4099	4100-4679	4680-5500
	Georgian Panelled			2000-2600	2601-3500	3501-4000	4001-4500	4501-5500
Number of Windows Supplied			3	4	5	6	7	8
For window styles V1 - V4S add £ (Total Price)			£489	£652	£815	£978	£1141	£1304

V1 - V4S Standard Vertical Window Configuration						V1 - V4S Singular Windows - Non-Standard Configuration	
	Horizontal Rib, Large Rib & Flush	Up To Door Panel Widths (mm)	1800-2125	2150-2650	2675-3125	Please contact the office for details	
	Georgian Panelled			1800-2125	2250-2650		
Number of Windows Supplied			4	5	6	£163	
For window styles V1 - V4S add £ (Total Price)			£652	£815	£978		

	Frame Colour Information	
	Window frames are white as standard - Colour matched frames available - Please state at time of order	£ Incl.

V7 Light Strip Window Configuration						
	Horizontal Rib, Large Rib & Flush	Up To Door Panel Widths (mm)	1800-2750	2750-3529	3529-4500	4500-5500
Number of Panels Supplied			2	3	4	5
For Light Strip Add (Total Price)			£316	£410	£521	£651

	Frame Colour Information	
	Coloured Doors - Light strip frame finished to match door panel. Timber Effect Doors - Light strip frame finished in nearest complementary RAL colour. Available with clear or stippled glass.	£ Incl

V8 - V9 Vertical Glazing Window Configuration					
	Horizontal Rib, Large Rib & Flush	Up To Door Panel Widths (mm)	1800-2125	2150-2650	2675-3125
Number of Panels Supplied			4	5	6
For Vertical Glazing Add (Total)			£2007	£2509	£3001

	Frame Colour Information	
	V8 & V9 Vertical Glazing is only available with silver frame.	£ Incl.

 Glazing is unavailable in a cut down top panel - Please see the Sectional Door panel chart on page 50 for further details.

## Glazing Options

	
Clear	Stippled

All prices are exclusive of VAT.

 For technical information on this product please refer to pages 50-55.



# Insulated ISO45 Wicket Doors

## Styles



Flush  



Large Rib  



Horizontal Rib 



Georgian Panelled 

	Wicket Door Price	
	<b>£2165</b>	

	Wicket Door Style	Door Width (mm)
		Flush, Large & Horizontal Rib
	Georgian Panelled	600

Please refer to Sectional Door Panel Height table on page 49 for Wicket Door Heights.



The height between the finished floor and the underside of the lintel must be at least the construction dimension height of the door. If this minimum is not met, the wicket door cannot be opened outward.



Available in Woodgrain texture



Available in Smooth texture

### Wicket Door Colour Information

Doors are supplied in the same texture and colour as the Sectional Door panels

Frame is finished in the same colour as the Sectional Door panels - unless timber effect - in these instances door frame will be finished in the nearest possible, solid RAL colour

Doors and frames are unavailable in Sage, Clay Stone, Duck Egg or any Bespoke Colour



### Handles Colour Options

Black	<b>£ Incl.</b>
Brush Silver	<b>£ Incl.</b>



### Spring Mechanism

Sectional Doors incorporating a Wicket Door are only available with Torsion Springs

Low Headroom Kit (Rear Mounting Kit)	<b>£227</b>
--------------------------------------	-------------



### Positioning of the Wicket Door



Symmetrical arrangement for garage door widths up to 3500mm.



Asymmetrical arrangement for garage door widths above 3500mm - optionally on the left with left hand hinge.



Asymmetrical arrangement for garage door widths above 3500mm - optionally on the right with right hand hinge.



Handles are available in black and silver

All prices are exclusive of VAT.

 For technical information on this product please refer to page 57.

## Styles



Flush  



Large Rib  





Horizontal Rib 





Georgian Panelled 

£	Sizing mm (W x H)	Flush, Large & Horizontal Rib Woodgrain	Georgian Panelled Woodgrain	Flush & Large Rib Smooth
	Metric			
	730 - 1300 x 1815 - 2500	<b>£2175</b>	<b>£2015</b>	<b>£2299</b>

	Door Operation	Side-Hinged
	Minimum Width	730
	Maximum Width	1350
	Minimum Height	1815
	Maximum Height	2500
	For <b>overframe width</b>	<b>+80mm Total</b>
	For <b>overframe height</b>	<b>+40mm Total</b>

	Colour Information	
	Essential Colours	<b>£ Incl.</b>
	Premium Colours, Finegrain & Timber Effect Finishes	<b>£ Incl.</b>
	Special RAL Colours	<b>£665</b>
	Bespoke Colours	<b>£ Incl.</b>

	Handles Colour Options	
	Black	<b>£ Incl.</b>
	Brush Silver	<b>£ Incl.</b>

	Locking Information	
	Single Point Locking	<b>£ Incl.</b>
	3-Point Locking	<b>£430</b>

 Available in Woodgrain texture

 Available in Smooth texture

Glazing Styles				
				
V1 - Plain	V2 - Rhombus	V3 - Cross	V4D - Diamond Leaded	V4S - Square Leaded

V1 - V4S Singular Windows - Non-Standard Configuration	
Please contact the office for details	<b>£163</b>

Glazing Options	
	
Clear	Stippled

All prices are exclusive of VAT.

 For technical information on this product please refer to page 56.

# Roller Garage Doors

## Colours & Finishes

### Standard Polyester Colours

Available in 77mm only.



Full colour matched box and guides included as standard.

 On Polyester Timber Effect doors the bottom lath will differ in colour or tone.

### Standard Polyester Colours

Available in both 55mm and 77mm.

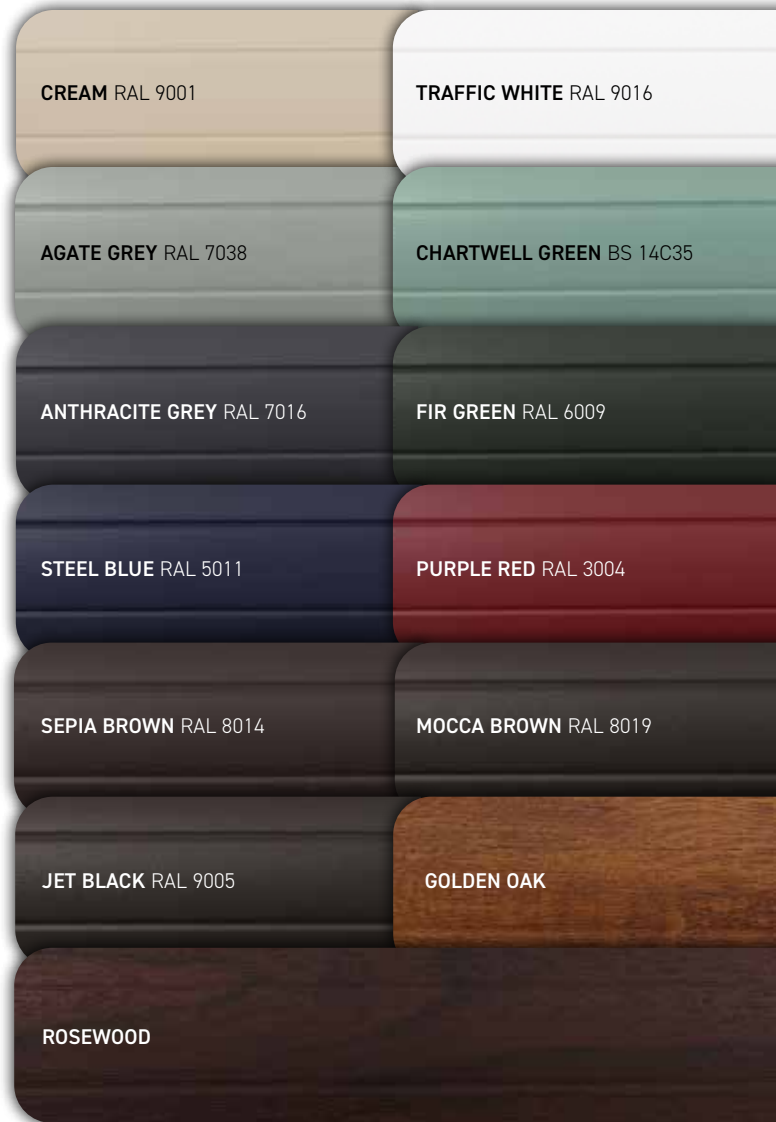

### Timber Effect



Choose from 3 high grade Timber Effect finishes



All colour samples depicted in this brochure are as close to the original manufacturer's colours as possible.

Garage doors supplied may vary in colour from the brochure representation.

Full colour matched box and guides included as standard.

Timber Effect	Box and Guide Colour
Irish Oak	Brown Beige RAL 1011 
Golden Oak & Rosewood	Mocca Brown RAL 8019 

## Roller Doors 77mm

£	Up to Overguide Height (mm)	Up to Overguide Width (mm)					
		1400 - 2600	2601 - 3000	3001 - 3500	3501 - 4000	4001-4500	4501 - 5000
	2000	£2536	£2748	£3209	£3289	£3516	£3899
	2125	£2600	£2822	£3236	£3342	£3592	£3968
	2250	£2684	£2907	£3289	£3395	£3676	£4053
	2375	£2785	£3008	£3342	£3501	£3777	£4153
	2500	£2896	£3119	£3368	£3560	£3893	£4270
	2743	£3024	£3252	£3448	£3686	£4021	£4403

Size Information (Overguide)	
Minimum Width	1400
Maximum Width	5000
Minimum Height	1831
Maximum Height	2743

Colour Information	
Standard Polyester Colours	£ Incl.
Timber Effect Finishes	£750
Timber Effect Finishes	£950



**Secured by Design**  
As standard

Now available in our 77mm Roller Garage Door Range up to 3m wide.

 Door must be fitted behind excluding vision laths and without low level emergency release.

Official Police Security Initiative

Box Heights	
Up to and including 2500mm high	300mm
Over 2500mm high	360mm
Full box included as standard	
Guide Widths	
Up to and including 3000mm wide	70mm
Over 3000mm wide	90mm
90mm guides available on smaller doors upon request	
Control Panel, Motor Options and Accessories	
Novorol wireless or wired control panel	£ Incl.
Somfy wireless or wired control panel as standard	£ Incl.
Teleco control panel	£ Incl.
Ansa control system (Single up to 3000mm)	£100
Ansa control system (Double over 3000mm)	£225
Somfy motor upgrade	£210
Low level emergency release	£318

Please confirm your preferred operating system at time of ordering

## Roller Doors 55mm

£	Up to Overguide Height (mm)	Up to Overguide Width (mm)	
		1600 - 2600	2601 - 3000
	2000	£2339	£2477
	2150	£2408	£2541
	2300	£2482	£2620

Size Information (Overguide)	
Minimum Width	1600
Maximum Width	3000
Minimum Height	1831
Maximum Height	2286

Colour Information	
Standard Polyester Colours	£ Incl.
Timber Effect Finishes	£610

Box Height	
205mm	
Guide Widths	
Up to 3000mm	65mm
Control Panel, Motor Options and Accessories	
Novorol wireless or wired control panel	£ Incl.
Somfy wireless or wired control panel as standard	£ Incl.
Teleco control panel	£ Incl.
Ansa control system	£100
Somfy motor upgrade	£210
Low level emergency release	£318

All prices are exclusive of VAT.

 For technical information on this product please refer to page 58.

## Colours & Finishes



LIGHT OAK



MEDIUM OAK



GOLDEN OAK



DARK OAK



MAHOGANY



ROSEWOOD



TEAK



EBONY



WALNUT

### Frame Bespoke and Heritage Colours

Frame and chassis colours are available in all essential and premium steel finishes. Please refer to page 4 for further details.

Door colours available in all essential and premium steel finishes.

For those seeking a more personalised touch, a wide range of popular heritage colours are also available on request to perfectly complement your chosen door and property style.

#### Bespoke Colours

RAL colours available on request



#### Popular Heritage Colours

Available on request



All colour samples depicted in this brochure are as close to the original manufacturer's colours as possible. Garage doors supplied may vary in colour from the brochure representation.

# Styles



**Suffolk**



**Chatham**



**Tudor**



**Windsor**



**Vertical**



**Horizontal**



**Madeley**



**Hertford**



**Henley**



**Caithness**



**Thame**



**Burlington**



**Dorset**



**Cleveland**



Handles are black as standard

# Timber Up & Over Garage Doors

## Timber Single Doors (Canopy and Retractable)



£	Up-to Door Panel Size (W x H)		Suffolk	Chatham, Tudor & Windsor	Vertical & Horizontal	Madeley & Hertford	Henley, Caithness & Thame	Burlington & Dorset	Cleveland
	Imperial	Metric							
	7'0" x 6'6"	2134 x 1981	£2294	£2647	£3084	£3477	£3549	£4262	£4282
	7'0" x 7'0"	2134 x 2134	£2294	£2647	£3084	£3477	£3549	£4262	£4282
	7'0" x 7'6"	2134 x 2286	£2438	£2827	£3307	£3740	£3734	£4417	£4514
	7'6" x 7'0"	2286 x 2134	£2459	£2895	£3239	£3839	£3834	£4619	£4641
	7'6" x 7'6"	2286 x 2286	£2565	£3005	£3439	£3899	£3937	£4627	£4767
	8'0" x 7'0"	2438 x 2134	£2618	£3098	£3476	£4135	£4036	£4788	£4894
	8'0" x 7'6"	2438 x 2286	£2719	£3218	£3645	£4202	£4167	£5004	£5157
	9'0" x 7'0"	2743 x 2134	£2734	£3339	£3695	£4865	£4256	£5018	£5172
	9'0" x 7'6"	2743 x 2286	£2909	£3591	£3928	£5270	£4518	£5438	£5607

Only available as Retractable

Door Operation	Canopy	Retractable
	Minimum Width	1956
Maximum Width	2438	2743
Minimum Height	1829	1860
Maximum Height	2134	2286
For <b>Canopy</b> overframe width		<b>+108mm Total</b>
For <b>Retractable</b> overframe width		<b>+140mm Total</b>
For <b>Overframe height</b> on all doors		<b>+45mm Total</b>

Colour Information	Essential Colours	£ Incl.
	Timber Effect	£ Incl.
	Painted Door Finishes	£ Incl.
Locking Information	4-Point Slam Latching	£ Incl.

Glazing Options	
	
Clear	Stippled
£ Incl.	£ Incl.

Leading Options	
	
Diamond Lattice	Square Lattice
£ Incl.	£ Incl.



All prices are exclusive of VAT.

# Timber Up & Over Garage Doors



## Timber Double Doors (Retractable only)

£	Up-to Door Panel Size (W x H)		Suffolk	Chatham, Tudor & Windsor	Vertical & Horizontal	Madeley & Hertford	Henley, Caithness & Thame	Burlington & Dorset	Cleveland
	Imperial	Metric							
	10'0" x 7'0"	3048 x 2134	£3607	£4220	£4624	£5947	£5390	£6367	£6494
	10'0" x 7'6"	3048 x 2286	£3814	£4496	£4940	£6395	£5783	£6724	£6997
	11'0" x 7'0"	3353 x 2134	£3821	£4574	£5024	£6395	£5840	£6857	£6997
	11'0" x 7'6"	3353 x 2286	£4049	£4790	£5380	£6844	£6244	£7250	£7454
	12'0" x 7'0"	3658 x 2134	£4057	£4885	£5407	£6887	£6278	£7457	£7550
	12'0" x 7'6"	3658 x 2286	£4316	£5123	£5801	£7287	£6722	£8056	£8053
	13'0" x 7'0"	3962 x 2134	£4327	£5447	£6230	£7382	£7234	£8600	£8694
	13'0" x 7'6"	3962 x 2286	£4327	£5447	£6230	£7720	£7247	£8587	£8730
	14'0" x 7'0"	4267 x 2134	£4613	£5845	£6707	£7869	£7811	£9299	£9417
	14'0" x 7'6"	4267 x 2286	£4613	£5845	£6740	£8346	£7825	£9314	£9457

Only available as Retractable

	<b>Door Operation</b>	<b>Retractable</b>		<b>Colour Information</b>	
	Minimum Width	2744		Essential Colours	£ Incl.
	Maximum Width	4267		Timber Effect	£ Incl.
	Minimum Height	1905		Painted Door Finishes	£ Incl.
	Maximum Height	2286			
	For <b>Overframe width</b>	<b>+140mm Total</b>		<b>Locking Information</b>	
	For <b>Overframe height</b> on all doors	<b>+45mm Total</b>		3-Point locking	£ Incl.

Glazing Options	
	
Clear	Stippled
£ Incl.	£ Incl.

Leading Options	
	
Diamond Lattice	Square Lattice
£ Incl.	£ Incl.

## Styles



**Suffolk**



**Chatham**



**Tudor**

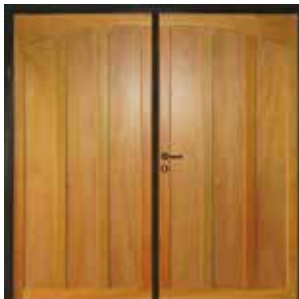

**Windsor**



**Vertical**



**Horizontal**



**Madeley**



**Hertford**



**Henley**



**Caithness**



**Thame**



**Burlington**



**Dorset**





**Cleveland**





Side-Hinged handles are available in black and silver

## Timber Side-Hinged Garage Doors

	Up-to Door Panel Size (W x H)		Suffolk	Chatham, Tudor & Windsor	Vertical & Horizontal	Madeley & Hertford	Henley, Caithness & Thame	Burlington & Dorset	Cleveland
	Imperial	Metric							
		7'0" x 6'6"	2134 x 1981	£3205	£3652	£3995	£4599	£4615	£5319
	7'0" x 7'0"	2134 x 2134	£3205	£3652	£3995	£4599	£4615	£5319	£5349
	7'0" x 7'6"	2134 x 2286	£3359	£3795	£4139	£4799	£4789	£5472	£5569
	7'6" x 7'0"	2286 x 2134	£3413	£3904	£4282	£4945	£4964	£5685	£5770
	7'6" x 7'6"	2286 x 2286	£3469	£3909	£4342	£5079	£4995	£5737	£5825
	8'0" x 7'0"	2438 x 2134	£3581	£4061	£4439	£5165	£5154	£5906	£6012
	8'0" x 7'6"	2438 x 2286	£3701	£4185	£4661	£5472	£5380	£6139	£6293

	Door Operation	Side-Hinged
	Minimum Width	1750
	Maximum Width	2438
	Minimum Height	1775
	Maximum Height	2286
	For <b>overframe width</b>	<b>+100mm Total</b>
	For <b>overframe height</b>	<b>+50mm Total</b>

	Threshold	
	Optional Threshold (for use with standard single-point locking)	<b>£75</b>

	Colour Information	
	Essential Colours	<b>£ Incl.</b>
	Timber Effect	<b>£ Incl.</b>
	Painted Door Finishes	<b>£ Incl.</b>

	Locking Information	
	3-Point Locking	<b>£249</b>

## Timber Side Personnel Doors

	Up-to Door Panel Size mm (W x H)	Suffolk	Chatham, Tudor & Windsor	Vertical & Horizontal	Madeley & Hertford	Henley, Caithness & Thame	Burlington & Dorset	Cleveland
		875 -1000 x 1875-2286	£1582	£1805	£2019	£2275	£2345	£2692

	Additional Size Information	
	For <b>overframe width</b>	<b>+100mm Total</b>
	For <b>overframe height</b>	<b>+50mm Total</b>

	Threshold	
	Optional Threshold (for use with standard single-point locking)	<b>£50</b>

	Colour Information	
	Essential Colours	<b>£ Incl.</b>
	Timber Effect	<b>£ Incl.</b>
	Painted Door Finishes	<b>£ Incl.</b>

	Locking Information	
	3-Point Locking	<b>£249</b>

## Colours & Finishes

### Essential Colours



TRAFFIC WHITE RAL 9016



JET BLACK RAL 9005



ANTHRACITE GREY RAL 7016



### Bespoke Colours

RAL colours available on request

### Premium Colours



PURE WHITE RAL 9010



CREAM RAL 9001



CLAY STONE RAL 080.80.05



LIGHT GREY RAL 7035



AGATE GREY RAL 7038



STONE GREY RAL 7030



SIGNAL GREY RAL 7004



WINDOW GREY RAL 7040



SILVER GREY RAL 7001



SLATE GREY RAL 7015



BLACK BROWN RAL 8022



PEBBLE GREY RAL 7032



CHARTWELL GREEN BS4800



SAGE NCS 4005-G80Y



FIR GREEN RAL 6009



MOSS GREEN RAL 6005



DUCK EGG RAL 260.80.10



BRILLIANT BLUE RAL 5007



COBALT BLUE RAL 5013



STEEL BLUE RAL 5011



CLAY BROWN RAL 8003



CHERRY BROWN CHROMA 3353



CHOCOLATE BROWN RAL 8017



RUBY RED RAL 3003



BROWN RED RAL 3011



Woodgrain Options



WHITE WOODGRAIN



MAGNOLIA



BLEACHED OAK



IRISH OAK



LIGHT OAK



TEAK



HONEY BEECH



GOLDEN BROWN



DARK OAK



ROSEWOOD



RED MAHOGANY



DARK MAHOGANY



ANTHRACITE GREY



EBONY

# Styles

## Single Up & Over Doors (Frame Included)



Weybridge (Gloss only)



Richmond (Gloss only)



Ashstead



Brockham



Cobham



Kingston

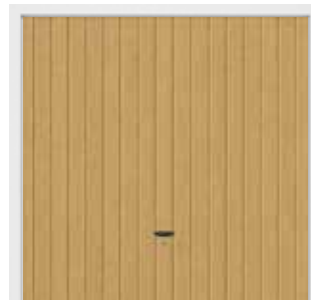

Verwood



Blandford



Woodside



Winchester



Lingfield



Betchworth



Chertsey



Sunbury

# GRP Garage Doors

## Single Up & Over Doors (Frame Included)

£	Up-to Door Panel Size (W x H)		Weybridge, Richmond, Ashstead, Cobham, Brockham, Verwood, Woodside, Kingston & Blandford	Winchester	Lingfield, Sunbury, Betchworth & Chertsey
	Imperial	Metric			
	7'0" x 7'0"	2134 x 2134	£2,518	£2,723	£2,916
	7'0" x 7'6"	2134 x 2286	£2,518	£2,723	£2,916
	7'6" x 7'0"	2286 x 2134	£2,852	£3,057	£2,975
	7'6" x 7'6"	2286 x 2286	£2,852	£3,057	£2,975
	8'0" x 7'0"	2438 x 2134	£2,932	£3,137	£3,052
	8'0" x 7'6"	2438 x 2286	£2,932	£3,137	-

📏	Door Operation	Weybridge, Richmond & Cobham	Ashstead	Brockham	Verwood	Woodside
	Minimum Width		2032	2032	1981	1524
Maximum Width		2438	2438	2388	2438	2286
Minimum Height		1930	1880	1981	1880	1880
Maximum Height		2134	2134	2134	2134	2134

📏	Door Operation	Kingston	Blandford & Winchester	Lingfield	Sunbury	Chertsey	Betchworth
	Minimum Width		2134	1524	2261	2185	2261
Maximum Width		2438	2438	2438	2438	2438	2134
Minimum Height		1982	1981	2134	2134	1880	1931
Maximum Height		2134	2134	2134	2134	2134	2134

For Canopy overframe width	+108mm Total
For Retractable overframe width	+136mm Total
For Canopy overframe height	+50mm Total
For Retractable overframe height	+68mm Total



Product over 2134mm high only available as retractable

🎨	Woodgrain Colour Options	
	Woodgrain, Essential Colours	£ Incl.
Premium Colours	£220	
Bespoke Colours	£POA	
High Gloss Colour Options (Weybridge and Richmond)		
Gloss White, Gloss Magnolia	£ Incl.	
Steel Frame Colour Options		
Essential colour steel frame & chassis	£ Incl.	

⚠️ Please note when trying to colour match garage doors with other UPVC products, always check a colour sample first. For example, Rosewood GRP doesn't match Rosewood UPVC where Dark Mahogany GRP is a closer match.

⚠️ All GRP doors are in a chassis with a 45mm head frame and 54mm legs. Retractable will be a solid door without a chassis in a 68mm all round frame.

Glazing Options				
Clear	Stippled	Black	Square Lattice	Diamond Lattice
Windows	Door Style			Price
Black	Richmond, Cobham			£220
Clear or Stippled	Richmond, Stippled			£450
Clear or Stippled	Weybridge, Betchworth, Lingfield, Chertsey, Sunbury			£660
Leading on windows	All Doors			POA

All prices are exclusive of VAT.

## Double Up & Over Doors (Frame Included)

	Up-to Door Panel Size (W x H)		Weybridge, Ashstead, Betchworth, Kingston & Chertsey	Verwood, Cobham & Richmond	Brockham	Lingfield
	Imperial	Metric				
	9'0" x 7'0"	2743 x 2134	-	£3,530	-	-
	9'0" x 7'6"	2743 x 2286	-	£3,530	-	-
	10'0" x 7'0"	3048 x 2134	-	£3,763	-	-
	10'0" x 7'6"	3048 x 2286	-	£3,763	-	-
	11'0" x 7'0"	3353 x 2134	-	£4,070	-	-
	11'0" x 7'6"	3353 x 2286	-	£4,070	-	-
	12'0" x 7'0"	2358 x 2134	-	£4,490	-	-
	12'0" x 7'6"	2358 x 2286	-	£4,490	-	-
	13'0" x 7'0"	3962 x 2134	-	£4,646	-	-
	13'0" x 7'6"	3962 x 2286	-	£4,646	-	-
	14'0" x 7'0"	4267 x 2134	£4,725	£4,725	£4,725	£4,725
	14'0" x 7'6"	2467 x 2286	£4,725	£4,725	-	£4,725
	15'0" x 7'0"	4572 x 2134	£5,223	£5,223	-	£5,223
	15'0" x 7'6"	4877 x 2286	£5,223	£5,223	-	£5,223
	16'0" x 7'0"	5182 x 2134	-	£5,529	-	-
	16'0" x 7'6"	5182 x 2286	-	£5,529	-	-

	Door Operation	Weybridge	Richmond	Ashstead	Brockham	Cobham
	Minimum Width	4115	2743	4115	4115	4540
	Maximum Width	4572	4877	4724	4267	4877
	Minimum Height	1930	1930	1981	1981	1930
	Maximum Height	2134	2286	2134	2134	2134

	Door Operation	Kingston	Verwood	Lingfield	Betchworth	Chertsey
	Minimum Width	4267	2438	4340	4267	4267
	Maximum Width	4724	4877	4724	4724	4572
	Minimum Height	2134	1880	2134	1931	1880
	Maximum Height	2286	2286	2286	21354	2286
	For overframe width	+68mm Total				
	For overframe height	+68mm Total				

	Woodgrain Colour Options	
	Woodgrain, Essential Colours	£ Incl.
	Premium Colours	£380
	Bespoke Colours	£POA
	High Gloss Colour Options (Weybridge and Richmond)	
	Gloss White, Gloss Magnolia	£ Incl.
Steel Frame Colour Options		
Essential colour steel frame & chassis	£ Incl.	



Please note when trying to colour match garage doors with other UPVC products, always check a colour sample first. For example, Rosewood GRP doesn't match Rosewood UPVC where Dark Mahogany GRP is a closer match.



All GRP doors are in a chassis with a 45mm head frame and 54mm legs. Retractable will be a solid door without a chassis in a 68mm all round frame.

# GRP Garage Doors











## Double Up & Over Doors (Continued)

Glazing Options				
Clear	Stippled	Black	Square Lattice	Diamond Lattice
				
Windows	Door Style			Price
Black	Richmond, Cobham			£450
Clear or Stippled	Richmond, Stippled			£980
Clear or Stippled	Weybridge, Betchworth, Lingfield, Chertsey, Sunbury			£1038
Leading on windows	All Doors			POA

# Garage Door Operators & Accessories

Images not to scale.	Product code	Description	Price
	Product code <b>OP00141</b>	<b>Novomatic 443</b> Energy saving with 0.5 Watt power supply in stand-by mode. <ul style="list-style-type: none"> <li>• Power supply: 230V / 50Hz</li> <li>• Pull and push force: 600N</li> <li>• Running speed: 18cm/s</li> <li>• Maximum door area: 10m<sup>2</sup></li> <li>• App Control available</li> <li>• CE marked</li> </ul>	<b>£440</b>
	Product code <b>OP00142</b>	<b>Novomatic 573 S</b> Energy saving with 0.5 Watt power supply in stand-by mode. <ul style="list-style-type: none"> <li>• Power supply: 230V / 50Hz</li> <li>• Pull and push force 800N</li> <li>• Running Speed: 24cm/s</li> <li>• Maximum door area: 18m<sup>2</sup></li> <li>• App Control available</li> <li>• CE marked</li> </ul>	<b>£520</b>
	Product code	<b>Novomatic 443 - Head Only</b>	<b>£240</b>
	Product code	<b>Novomatic 573 S - Head Only</b>	<b>£280</b>
	<b>OP00004</b>	<b>ZS20 1 Piece Novomatic Boom</b> Suitable for: Novomatic 443 / 573 S, Novorol NR-20, Novoport	<b>£250</b>
	<b>OP00005</b>	<b>ZS40 2 Piece Novomatic Boom</b> Suitable for: Novomatic 443 / 573 S, Novorol NR-20, Novoport	<b>£250</b>
		<b>Novoport® Speed Operator</b> Energy saving with <0.5 Watt power supply in stand-by mode. <ul style="list-style-type: none"> <li>• Power supply: 230v / 50Hz</li> <li>• Tensile and compressive force: 650N</li> <li>• Running Speed: 29cm/s</li> <li>• Maximum door area: 17m<sup>2</sup></li> <li>• App Control available</li> <li>• CE marked</li> </ul>	<b>£484</b>
	<b>OP00007</b>	<b>Novorol NR-20 Control Unit</b> Control unit for insulated roller shutter doors, for wired safety edges.	<b>£380</b>







# Garage Door Operators & Accessories



Images not to scale.	Product code	Description	Novomatic compatible	Novoport® compatible	Price
	<b>OP00083B</b>	<b>Bi-directional Adjustment module and Gateway New Generation</b> Smart Home garage door system, for control of your door through app, comes with module and gateway using Homematic IP system, compatible with Alexa and Google Home. One module supplied as standard, for control of additional motors request additional modules. *Must be purchased with through-beam photocells.			<b>£350</b>
	<b>OP00112</b>	<b>Smart Garage Module</b> Extra module for Homematic IP gateway, required for each additional door.			<b>£155</b>
		<b>Novoferm Wi-Fi Smart Garage Module</b> Extra module for Homematic IP gateway, required for each additional door. *Should be purchased with through-beam photocells.			<b>£93</b>
	<b>OP00077</b>	<b>Mini-Novotron 522 hand transmitter</b> 2-channel, 433 MHz, KeeLoq rolling code	✓	✓	<b>£52</b>
	<b>OP00079</b>	<b>Mini-Novotron 524 hand transmitter</b> 4-channel, 433 MHz, KeeLoq rolling code	✓	✓	<b>£57</b>
	<b>OP00078</b>	<b>Mini-Novotron 522 Design hand transmitter</b> 2-channel, 433 MHz, KeeLoq rolling code	✓	✓	<b>£78</b>
	<b>OP00080</b>	<b>Mini-Novotron 524 Design hand transmitter</b> 4-channel, 433 MHz, KeeLoq rolling code	✓	✓	<b>£83</b>
	<b>OP00092</b>	<b>868MHz Hand Transmitter Black Design</b> 3-channel, 868 MHz, KeeLoq rolling code	✓	✓	<b>£98</b>
	<b>OP00086</b>	<b>Wall mounting/silicon case hand transmitter</b> Suitable for use as case and wall mounting for Mini-Novotron 522 Design/524 Design and for Mini-Novotron 522/524			<b>£15</b>
	<b>OP00019</b>	<b>Mini Novotron 502 Hand Transmitter</b> 2-channel, 433 MHz, KeeLoq rolling code	✓	✓	<b>£48</b>
	<b>OP00023</b>	<b>Novotron Handset clip</b> For Novotron 502 & 504 handsets			<b>£15</b>

# Garage Door Operators & Accessories

Images not to scale.	Product code	Description	Novomatic compatible	Novoport® compatible	Price
	OP00030	<b>Signal 218 - Wireless Coded Keypad</b> 10 codes, 433 MHz, KeeLoq rolling code with stainless steel cover, backlit in UV-resistant material	✓	✓	£124
	OP00031	<b>Signal 111 - Wireless Remote Wall Switch</b> 2-channel, 433 MHz, KeeLoq rolling code for controlling 2 operators or 1 operator and 1 outside lighting in UV-resistant material	✓	✓	£93
	OP00025	<b>Signal 107</b> Push button rocker switch, 1 channel, 7m wired connection	✓	✓	£42
	OP00120	<b>Novoferm Sectional Easy Clip Photocell Kit</b> 10-30 V, IP 44 Range: 7m Suitable for: Novomatic 443 / 573 S, Novorol NR-20, Novoport	✓	✓	£109
	OP00088	<b>Extra 626 - Through-beam Photocells</b> 20-28 V, IP 50 Range: 8m Suitable for: Novomatic 443 / 573 S, Novorol NR-20, Novoport	✓	✓	£109
	OP00068	<b>Novomatic Receiver Card 433MHz</b> Suitable for: Novomatic 443 / 573 S, Novorol NR-20, Novoport	✓	✓	£74
	OP00091	<b>Novomatic Receiver Card 868MHz</b> Suitable for: Novomatic 443 / 573 S, Novorol NR-20, Novoport	✓	✓	£74
	OP00030	<b>Signal 218 - Wireless Coded Keypad</b> 10 codes, 433 MHz, KeeLoq rolling code with stainless steel cover, backlit in UV-resistant material	✓	✓	£124
	OP00082	<b>Novomatic 423 with battery Back-up (Accu)</b> 423 operator complete with Battery back-up system that will temporarily keep your garage door in full operation during a power cut.			£770
	OP00084	<b>Solar Module</b> For Novomatic 423 with battery back-up (Accu)	✓		£258
	AZAD1080	<b>De-Latch for Novoferm retractable lifting up &amp; over doors</b> Suitable for 2 point rigid bar and cable locking systems, supplied with complete locking de-latching system	✓		£206
	OP00126	<b>NR-20 Bottom Slat Transmitter - RSE Residential-Set</b> Wireless safety edge transmitter for Novoferm insulated roller shutters. Compatible with Novorol NR-20.			£124

# Garage Door Operators & Accessories

Images not to scale.	Product code	Description	Novomatic compatible	Novoport® compatible	Price
	OP00033	<b>Telescopic Operator Bracket</b> Fixes the operator securely when fitted to the top of Novoferm sectional doors	✓		£43
	OP00034	<b>Extra 304 - External Manual Release</b> For Novoferm sectional doors fitted with a handle	✓	✓	£41
	OP00035	<b>Extra 305 - External Manual Release</b> Round cylinder for Novoferm sectional doors fitted without a handle	✓	✓	£41
	OP00036	<b>Extra 312 - External Manual Release</b> For Novoferm up & over garage doors	✓		£36
	OP00042	<b>LED Lighting Kit</b> Up to 3000mm door width	✓	✓	£584
	OP00043	<b>LED Lighting Kit</b> Up to 4000mm door width	✓	✓	£636
	OP00044	<b>LED Lighting Kit</b> Up to 5000mm door width	✓	✓	£690

Images not to scale.	Product code	Accessory	Novomatic compatible	Novoport® compatible	Price
	RCXX006SMF	<b>Somfy Rollixo iO Control Panel</b> Control Panel for insulated roller shutter doors, for wired safety edges.			£361
	OP00130	<b>Somfy Keygo 4 iO</b> 4 channel, 433MHz.			£72
	OP00132	<b>Somfy Wall iO Wireless</b> 3 channel, 433MHz.			£72
	OP00133	<b>Somfy Connectivity Kit</b> Easily control your Somfy operators by app and voice. Works with Google Home & Alexa.			£154
	OP00134	<b>Somfy Keypad 2 iO Wireless</b> Secure coded entry for Somfy operators.			£144
	OP00135	<b>Somfy Reflective Photocell Kit</b> 24 VAC/DC, IP 67 Range: 12m Suitable for: Somfy Rollixo iO Control Panel Wires not included, Class II - Double insulation			£134

# Technical Guides and Information

## Contents

Steel Up and Over Garage Doors	40-46
Steel Side Hinged Doors	47-48
Steel Side Personnel Doors	49
ISO Sectional Garage Doors	50-55
Sectional ISO EVO Matching Side Doors	56
Insulated ISO45 Wicket Doors	57
Novorol Insulated Roller Doors	58
Warranty and Maintenance	59

## UP AND OVER GARAGE DOORS CANOPY GEAR TYPE (HEIGHT)

Door Height			=H1+50	= H1-20	= H1-90				
Imp	mm	H1	H2	H3	H4	H5	H6	R	C
6'4"	1931	1931	1981	1911	1841	1300	49	675	625
6'6"	1981	1981	2031	1961	1891	1300	49	725	657
6'10"	2085	2085	2135	2065	1995	1300	49	825	775
7'0"	2134	2134	2184	2114	2044	1300	49	880	825

**For Maximum and Minimum Door Sizes refer to the current Price List**

H1 = Internal Frame Height

H2 = Minimum Height from floor to underside of ceiling

H3 = Minimum Brickwork Opening Height

H4 = Clear Drive Through Height (Internal Handle is the lowest point)

H5 = How far the door extends into the garage

H6 = Kick Up (The height above the Internal Frame Height the door panel rises during the opening cycle)

R = The Arc of travel of the bottom edge of the door

C = The canopy (How far the door protrudes from the frame front)

**Note:** The Kick up is greater than the frame Lintel Height and peeks above the Lintel at 1100mm into the garage from the frame front

**Frame Header Dimensions 45mm High x 40mm Deep**

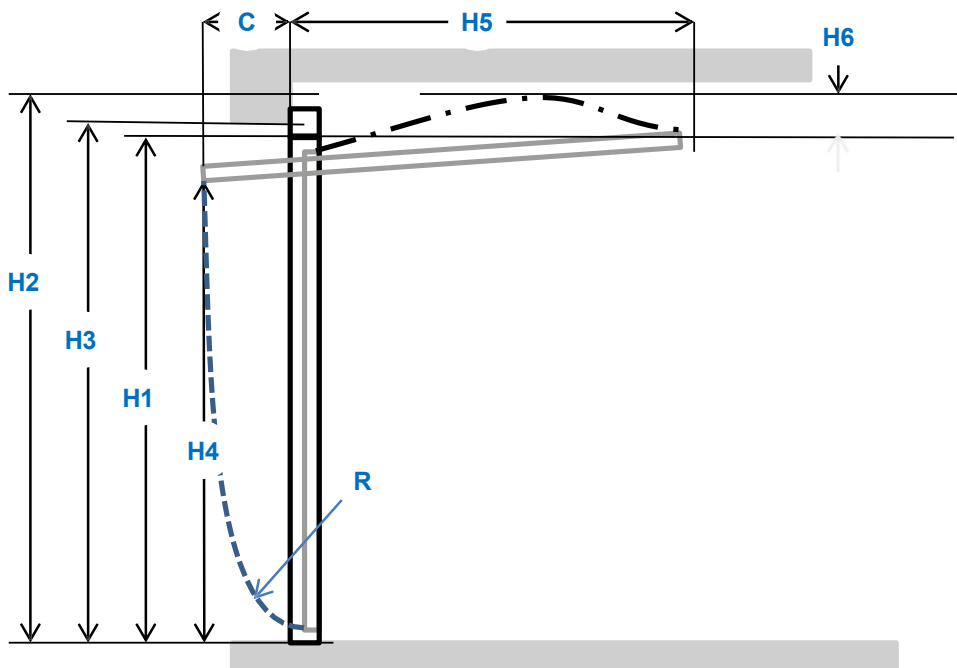

## UP AND OVER GARAGE DOORS CANOPY GEAR TYPE (WIDTH)

Door Width		Common Dimensions			54mm Wide x 40mm Deep Frames	
		=W1	=W1+24	=W1+108	=W1+114	
Imp	mm	W1	W2	W4	W5	2199
6'10"	2085	2085	2085	2109	2193	2199
7'0"	2134	2134	2134	2158	2242	2248
7'3"	2210	2210	2210	2234	2318	2324
7'5"	2261	2261	2261	2285	2369	2375
7'6"	2286	2286	2286	2310	2394	2400
8'0"	2438	2438	2438	2462	2546	2552

For Maximum and Minimum Door Sizes refer to the current Price List

- W1 = Internal Frame Width
- W2 = Clear Drive through Width
- W3 = Minimum Brickwork Opening
- W4 = External Frame Width
- W5 = Recommended Brickwork Opening Width

### Fitting behind the opening

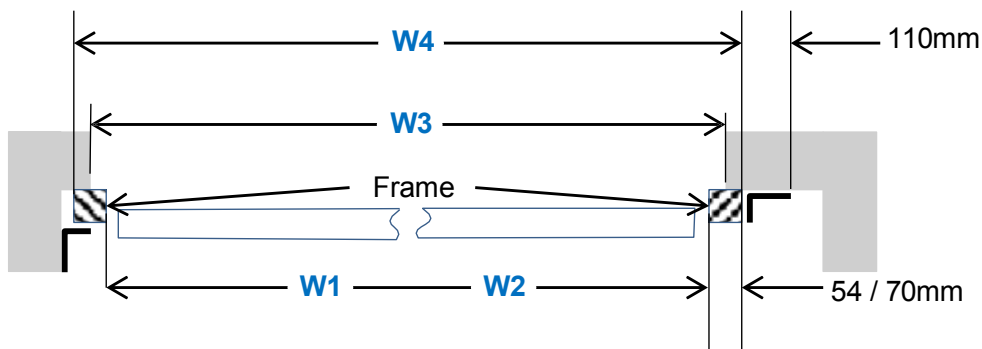

### Fitting within the opening



# Steel Up & Over Garage Doors

## INTERNAL FRAME SIZE (ORDERING SIZE)

### TO EXTERNAL FRAME DIMENSIONS FOR UP AND OVER DOORS

		External Frame Dimensions / Over Frame Size			
Imperial Size	Internal Frame Size	Canopy	Single Retractable	Double Retractable	Side-Hinged
ft x in	mm x mm	Leg Width x Head Height			
		54mm x 45mm	70mm x 45mm	68mm x 68mm	50mm x 50mm
W x H	W x H	W x H	W x H	W x H	W x H
7'0" x 6'6"	2134 x 1981	2242 x 2026	2274 x 2026	-	2234 x 2031
7'0" x 7'0"	2134 x 2134	2242 x 2179	2274 x 2179	-	2234 x 2184
7'0" x 7'6"	2134 x 2286		2274 x 2331	-	2234 x 2336
7'6" x 6'6"	2286 x 1981	2394 x 2026	2426 x 2026	-	2386 x 2031
7'6" x 7'0"	2286 x 2134	2394 x 2179	2426 x 2179	-	2386 x 2184
7'6" x 7'6"	2286 x 2286		2426 x 2331	-	2386 x 2336
8'0" x 6'6"	2438 x 1981	2546 x 2026	2578 x 2026	-	2538 x 2031
8'0" x 7'0"	2438 x 2134	2546 x 2179	2578 x 2179	-	2538 x 2184
8'0" x 7'6"	2438 x 2286		2578 x 2331	-	2538 x 2336
9'0" x 6'6"	2743 x 1981	-	2883 x 2026	-	-
9'0" x 7'0"	2743 x 2134	-	2883 x 2179	-	-
9'0" x 7'6"	2743 x 2286	-	2883 x 2331		-
10'0" x 7'0"	3048 x 2134	-	-	3184 x 2202	-
10'0" x 7'6"	3048 x 2286	-	-	3184 x 2354	-
11'0" x 7'0"	3353 x 2134	-	-	3489 x 2202	-
11'0" x 7'6"	3353 x 2286	-	-	3489 x 2354	-
12'0" x 7'0"	3658 x 2134	-	-	3794 x 2202	-
12'0" x 7'6"	3568 x 2286	-	-	3794 x 2354	-
13'0" x 7'0"	3962 x 2134	-	-	4098 x 2202	-
13'0" x 7'6"	3962 x 2286	-	-	4098 x 2354	-
14'0" x 7'0"	4267 x 2134	-	-	4403 x 2202	-
14'0" x 7'6"	4267 x 2286	-	-	4403 x 2354	-
15'0" x 7'0"	4572 x 2134	-	-	4708 x 2202	-
15'0" x 7'6"	4572 x 2286	-	-	4708 x 2354	-
16'0" x 7'0"	4877 x 2134	-	-	5013 x 2202	-
16'0" x 7'6"	4877 x 2286	-	-	5013 x 2354	-

## SINGLE UP AND OVER GARAGE DOORS RETRACTABLE GEAR TYPE (HEIGHT)

For Doors With Frame Header 45mm High and 40mm Deep (Steel Doors)

Door Height			=H1+45	Fitting to Return = H1	Fitting Between = H1+50	=H1-150				Lever Arm Crank Height
Imp	mm	H1	H2	H3R	H3B	H4	H5	R	C	
6'6"	1981	1981	2026	1981	2031	1831	1735	1020	225	1030
7'0"	2134	2134	2180	2134	2184	1984	1890	1100	265	1100
7'2+	2200	2200	2245	2200	2250	2050	1965	1140	305	1140

For Doors With Frame Header 68mm High and 60mm Deep (Steel Doors)

Door Height			=H1+68	Fitting to Return = H1	Fitting Between = H1+73	=H1-100				Pivot Arm Crank Height
Imp	mm	H1	H2	H3R	H3B	H4	H5	R	C	
6'6"	1981	1981	2049	1981	2054	1881	1880	880	40	1050
7'0"	2134	2134	2202	2134	2177	2034	1880	1030	230	1200
7'2+	2200	2200	2268	2200	2273	2100	1880	1090	260	1265

- H1 = Internal Frame Height
- H2 = External Frame Height
- H3 = Minimum Brickwork Opening Height
- H4 = Clear Drive Through Height (Internal Handle is the lowest point)
- H5 = How far the door extends into the garage
- R = The arc of travel of the bottom edge of the door
- C = The canopy (How far the door protrudes from the frame front)

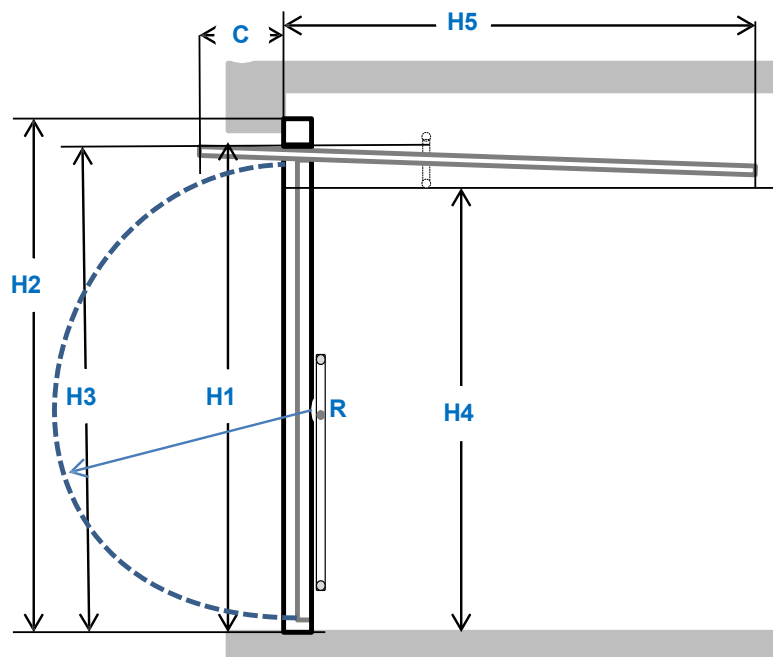

**Tolerance:-**  
Height = 25mm  
(Typically, Split 12 / 13mm  
Top / Bottom)

(The difference between the  
Actual Door Panel and the  
Internal Frame Dimensions)

# Steel Up & Over Garage Doors

## SINGLE UP AND OVER GARAGE DOORS RETRACTABLE GEAR TYPE (WIDTH)

Door Width		Common Dimensions				70mm Wide Frame		For GRP Doors 68mm Wide Frame	
		=W1+24	=W1-100	=W1-36	=W1+140	=W1+160	= W1 + 136	=W1 + 146	
Imp	mm	W1	W2	W3A	W3B	W4	W5	W4	W5
6'10"	2085	2085	2109	1985	2049	2225	2245	2221	2231
7'0"	2134	2134	2158	2034	2098	2274	2294	2270	2280
7'3"	2210	2210	2234	2110	2174	2350	2370	2346	2356
7'5"	2261	2261	2285	2161	2225	2381	2421	2397	2407
7'6"	2286	2286	2310	2186	2250	2426	2446	2422	2432
8'0"	2438	2438	2462	2338	2402	2580	2598	2574	2584
9'0"	2743	2743	2767	2643	2707	2883	2903	N / A	N / A
10'0"	3048	3048	3072	2948	3011	3188	3208	N / A	N / A

W1 = Internal Frame Width

W2 = Minimum Brickwork Opening

W3A = Clear Drive through Width – Above the Crank of the Pivot Arm

W3B = Clear Drive through Width – Below the Crank of the Pivot Arm

W4 = External Frame Width

W5 = Recommended Brickwork Opening Width

NOTE – The crank in the pivot arm is 1000mm from the floor on a 1981mm high door 1100mm from the floor on a 2134mm high door

NOTE – When the Side Wall is more than 400mm away from the opening aperture then use NFSP 0501 "Adjustable Track Hanging Kit" this allows the tracks to be hung from the rafters above

### Fitting behind the opening

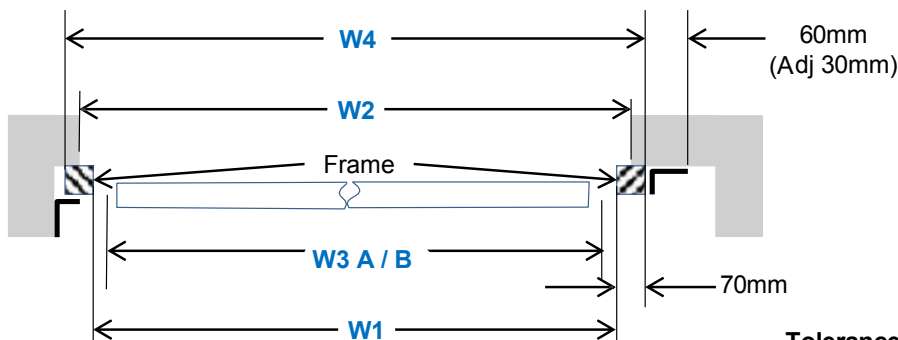

### Tolerance:-

Width Framed Doors = 8mm  
Width Un-Framed Doors = 18mm

### Fitting within the opening

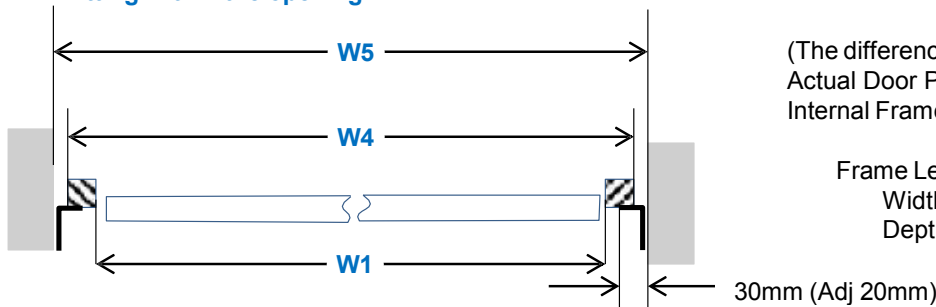

(The difference between the Actual Door Panel and the Internal Frame Dimensions)

Frame Leg Dimensions  
Width = 70mm  
Depth = 40mm

## DOUBLE UP AND OVER GARAGE DOORS RETRACTABLE GEAR TYPE (HEIGHT)

Door Height			=H1+68	=H1	=H1-150				
Imp	mm	H1	H2	H3	H4	H5	R	C	T
6'6"	1981	1981	2048	1981	1831	1870	900	60	1903
7'0"	2134	2134	2202	2134	1984	1870	1040	210	2055
7'6"	2286	2286	2354	2286	2136	1870	1180	360	2207
8'0"	2438	2438	2506	2438	2288	1870	1320	510	2359

- H1 = Internal Frame Height
- H2 = External Frame Height
- H3 = Minimum Brickwork Opening Height
- H4 = Clear Drive Through Height (Internal Handle is the lowest point)
- H5 = How far the door extends into the garage
- R = The arc of travel of the bottom edge of the door
- C = The canopy (How far the door protrudes from the frame front, Assumes 70mm thick frame)
- T = Horizontal Track Height, Measured from the floor to the lower edge of the horizontal track by the frame, the rear end of the track should be 50mm lower than the front
- K = Kick up = 43mm

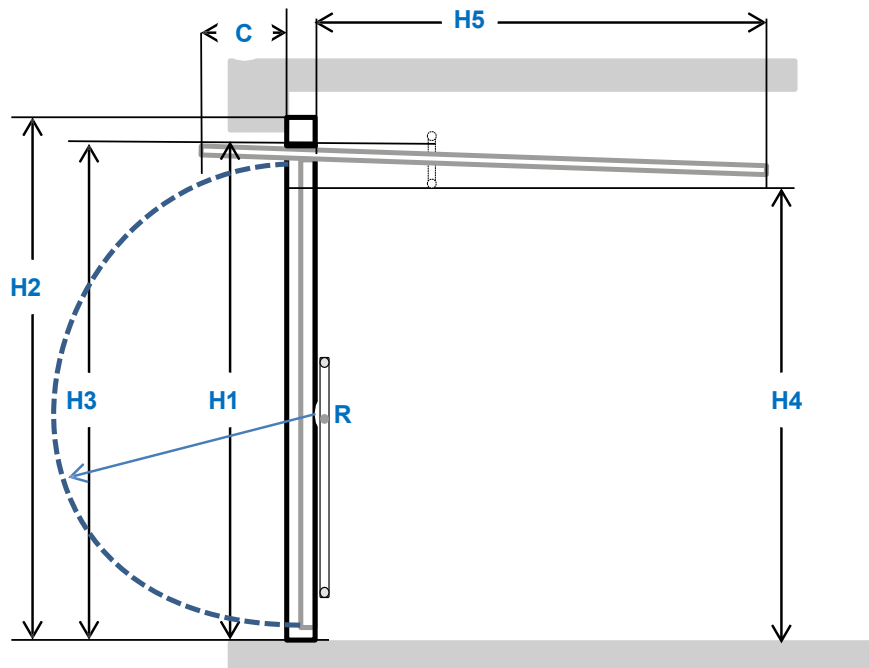

Frame Header Dimensions  
 Height = 68mm  
 Depth = 75mm

# Steel Up & Over Garage Doors

## DOUBLE UP AND OVER GARAGE DOORS RETRACTABLE GEAR TYPE (WIDTH)

Door Width		Common Dimensions				70mm Wide Frame	
		=W1+24	=W1-120	=W1-50	=W1+140	=W1+150	
Imp	Mm	W1	W2	W3A	W3B	W4	W5
8'0"	2438	2438	2462	2318	2388	2578	2588
10'0"	3048	3048	3072	2928	2998	3188	3198
12'0"	3657	3657	3682	3538	3607	3797	3807
14'0"	4267	4267	4291	4147	4217	4407	4417
16'0"	4877	4877	4901	4757	4827	5017	5027

**For Maximum and Minimum Door Sizes refer to the current Price List**

- W1 = Internal Frame Width
- W2 = Minimum Brickwork Opening (When Fitted Behind the Opening)
- W3A = Clear Drive through Width – Above the Bottom of the Pivot Arm
- W3B = Clear Drive through Width – Below the Bottom of the Pivot Arm
- W4 = External Frame Width
- W5 = Recommended Brickwork Opening Width (When Fitting within the opening)

NOTE – The Bottom of the Pivot Arm when the door is open is  
 820mm from the floor on a 1981mm high doors  
 970mm from the floor on a 2134mm high doors  
 1120mm from the Floor on a 2286mm high doors

The Door panel is 20mm smaller than the Internal Frame Size

### Fitting behind the opening

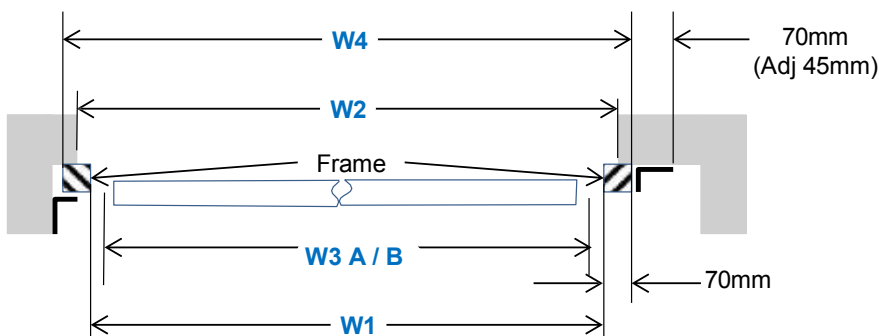

### Fitting within the opening

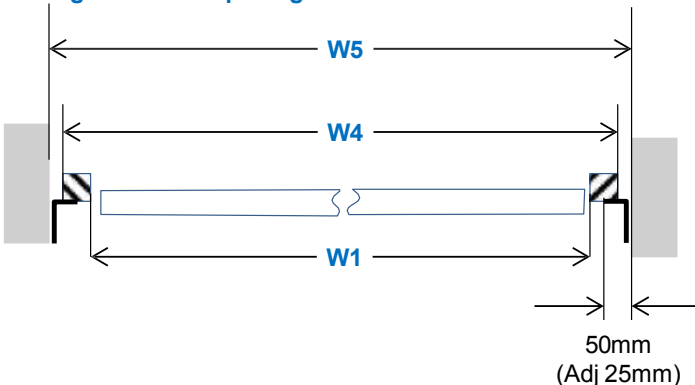

Frame Leg Dimensions  
 Width = 70mm  
 Depth = 75mm

## STEEL SIDE HINGED GARAGE DOORS (HEIGHT)

### Standard Height Doors Only

Door Height		H1	H2	H3	H4	H5
Imp	mm					
6'6"	1981	1981	2031	2036	1866	1806
7'0"	2134	2134	2184	2189	2119	2059
7'6"	2286	2286	2336	2341	2271	2211

### Special Height Doors

Door Height		H2	H3	H4	H5
From	To				
	1980	H1	H1+50	H1+55	H1-15
1982	2133	H1	H1+50	H1+55	H1-15
2135	2285	H1	H1+50	H1+55	H1-15

For Maximum and Minimum Door Sizes refer to the current Price List

### Side-Hinged Threshold

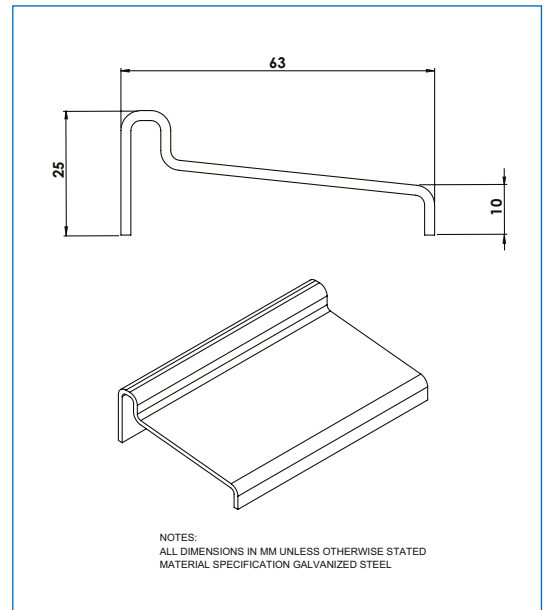

- H1 = Internal Frame Height
- H2 = External Frame Height
- H3 = Minimum Brickwork Opening Height
- H4 = Clear Drive Through Height – Internal Weather Seal, Lower Edge
- H5 = Clear Drive Through Height – When Door Stays are Installed (Locally, Edges of Opening)

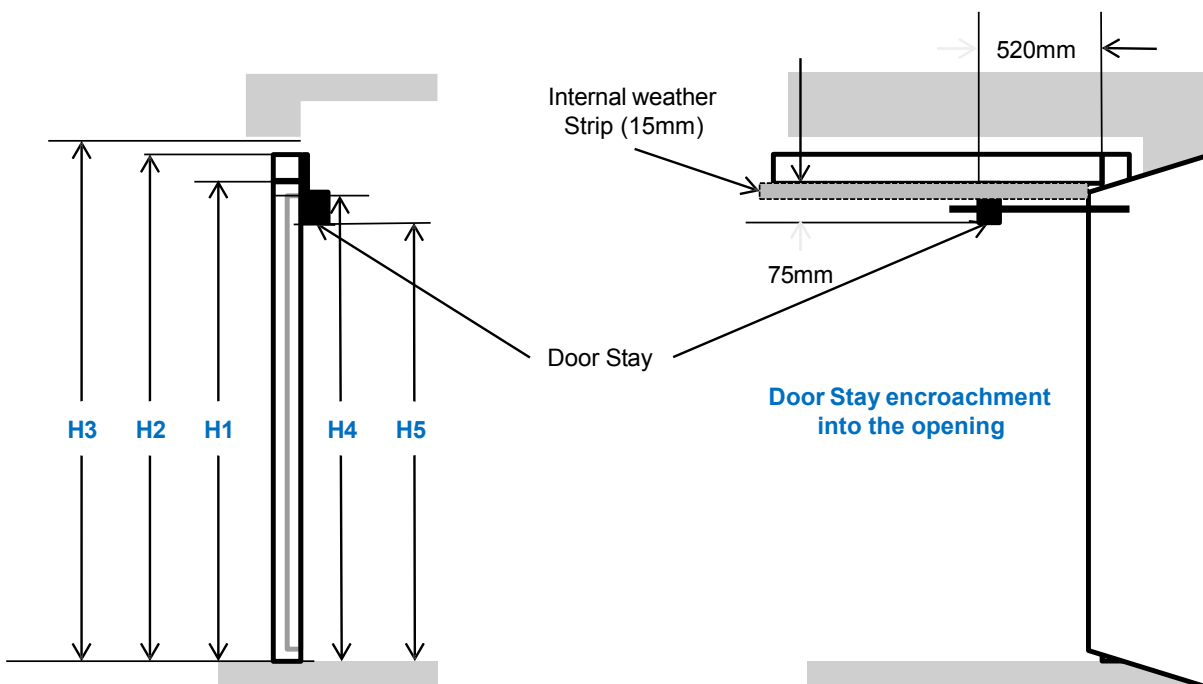

# Steel Side-Hinged Garage Doors

## STEEL SIDE-HINGED GARAGE DOORS (WIDTH)

Door Width		Common Dimensions				50mm Wide Frame	
		=W1+10	= W1-100	= W+100	= W+110	= W+20	
imp	mm	W1	W2	W3	W4	W5	W6
6'6"	1981	1981	1991	1881	2081	2091	2001
7'0"	2134	2134	2144	2034	2234	2294	2154
7'6"	2286	2286	2296	2186	2386	2446	2306
8'0"	2438	2438	2448	2338	2538	2598	2458

For Maximum and Minimum Door Sizes refer to the current Price List

- W1 = Internal Frame Width
- W2 = Minimum Brickwork Opening
- W3 = Clear Drive through Width – Door Open to 90 Degrees
- W4 = External Frame Width
- W5 = Recommended Brickwork Opening Width – Fitting between the brickwork
- W6 = Recommended Brickwork Opening Width – Fitting behind the brickwork

### Fitting within the opening (Recommended)

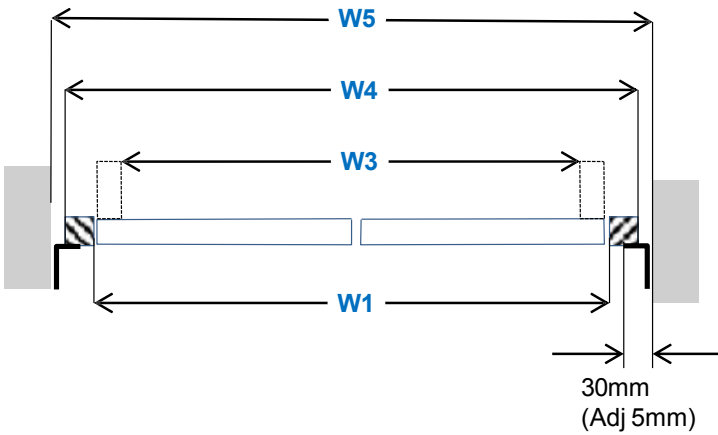

### Side-Hinged Threshold

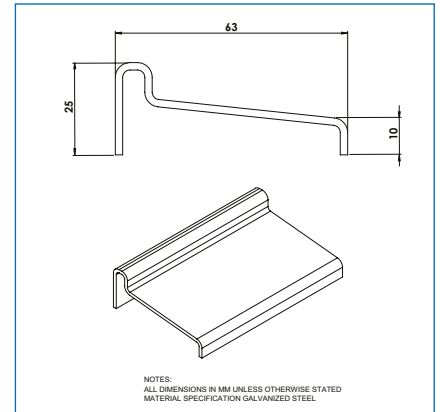

Door Stays to be adjusted to ensure the door panels do not hit the brickwork

### Fitting behind the opening

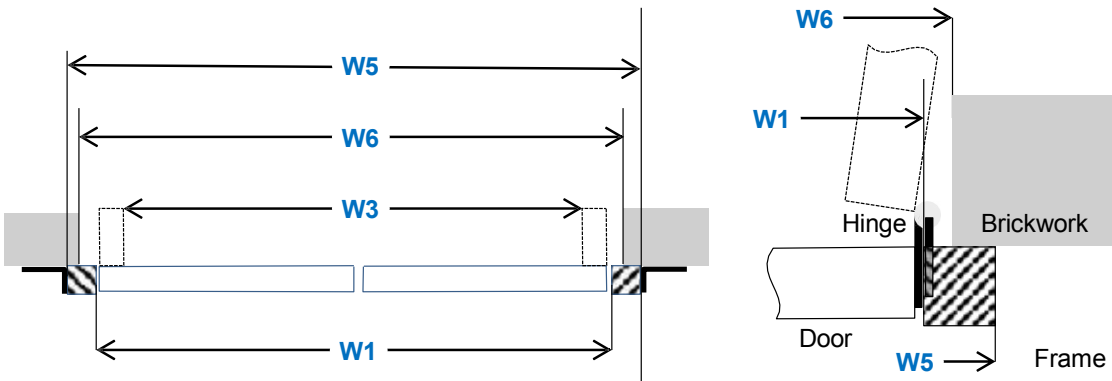

## STEEL MATCHING PERSONNEL DOORS SIDE HINGE GEAR TYPE

Door Width			=W1+100	= W1+110	= W1-20
Imp	mm	W1	W2	W3	W4
2'10 1/2"	875	875	1011	1021	820
3'3 1/3"	1000	1000	1136	1146	945

(To match Steel Up & Over Doors )

W1 = Internal Frame Width  
 W2 = External Frame Width  
 W3 = Recommended Brickwork Opening Width  
 – Fitting between the brickwork  
 W4 = Clear Walk through Width  
 – Door Open to 90 Degrees

Frame Leg Dimensions  
 – 50mm Wide – 63mm Deep

Inward Opening Doors - variations

W4 – Clear Walk through Width = Internal Frame Width – 65mm

H4 – Clear Walk through Height = Internal Frame Height – 15mm

Note:

When fitting behind the brickwork the Internal Frame Width should be = Brickwork Opening - 40mm  
 This is because the Hinge Knuckle overhangs the frame and needs allowing for.

Fitting within the opening

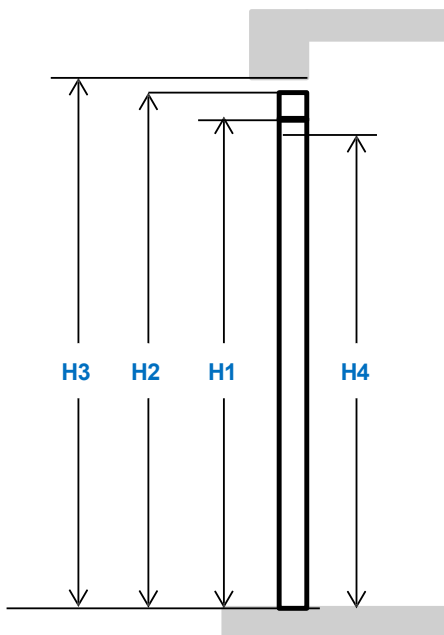
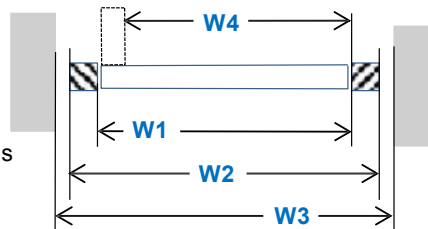

Door Height			=H1+50	=H1+55	=H1-20
Imp	mm	H1	H2	H3	H4
6'2"	1875	1875	1925	1930	1855
6'6"	2000	2000	2050	2055	1980
7'0"	2125	2125	2175	2180	2115

H1 = Internal Frame Height  
 H2 = External Frame Height  
 H3 = Minimum Brickwork Opening Height  
 H4 = Clear Walk through Height (Lowest point, Internal Weather Bead)

Frame Lintel Dimensions  
 - 50mm High; 63mm Deep

Doors to be ordered by External Frame Size or Brickwork Opening Dimensions

# ISO Sectional Garage Doors

## SECTIONAL & WICKET DOOR PANEL HEIGHTS (MM)

Overall Total Height	Number of Sections	Bottom Section	Lock Section	Middle Section 1	Middle Section 2	Middle Section 3	Top Section	Height & Clearance Required for Wicket Door	Georgian Style Available	Available With Windows
1800	4	450	450	450			450	1830	✓	✓
1825	4	450	450	450			450	1880	✓	✓
1850	4	500	450	450			450	1880	✓	✓
1875	4	500	450	450			450	1930	✓	✓
1900	4	500	500	450			450	1930	✓	✓
1925	4	500	500	450			450	1980	✓	✓
1950	4	500	500	500			450	1980	✓	✓
1975	4	500	500	500			450	2030	✓	✓
2000	4	500	500	500			500	2030	✓	✓
2025	4	500	500	500			500	2080	✓	✓
2050	4	525	525	500			500	2080	✓	✓
2075	4	525	525	500			500	2105	✓	✓
2100	4	525	525	525			525	2130	✓	✓
2125	4	525	525	525			525	2155	✓	✓
2150	5	450	450	450	450		350	2180	✗	✗
2175	5	450	450	450	450		375	2230	✗	✗
2200	5	450	450	450	450		400	2230	✗	✗
2225	5	450	450	450	450		425	2280	✗	✗
2250	5	450	450	450	450		450	2280	✓	✓
2275	5	450	450	450	450		450	2330	✓	✓
2300	5	500	450	450	450		450	2330	✓	✓
2325	5	500	450	450	450		450	2380	✓	✓
2350	5	500	500	450	450		450	2380	✓	✓
2375	5	500	500	450	450		450	1980	✓	✓
2400	5	500	500	500	450		450	1980	✓	✓
2425	5	500	500	500	450		450	1980	✓	✓
2450	5	500	500	500	500		450	1980	✓	✓
2475	5	500	500	500	500		450	1980	✓	✓
2500	5	500	500	500	500		500	2030	✓	✓
2525	5	500	500	500	500		500	2030	✓	✓
2550	5	525	525	500	500		500	2080	✓	✓
2575	5	525	525	500	500		500	2080	✓	✓
2600	5	525	525	525	525		500	2230	✓	✓
2625	5	525	525	525	525		525	2230	✓	✓
2650	5	525	525	525	525		525	2230	✓	✓
2675	6	450	450	450	450	450	425	2280	✗	✗
2700	6	450	450	450	450	450	450	2280	✓	✓
2725	6	450	450	450	450	450	450	2330	✓	✓
2750	6	500	450	450	450	450	450	2330	✓	✓
2775	6	500	450	450	450	450	450	2380	✓	✓
2800	6	500	500	450	450	450	450	2380	✓	✓
2825	6	500	500	450	450	450	450	1980	✓	✓
2850	6	500	500	500	450	450	450	1980	✓	✓
2875	6	500	500	500	450	450	450	1980	✓	✓
2900	6	500	500	500	500	450	450	1980	✓	✓
2925	6	500	500	500	500	450	450	1980	✓	✓
2950	6	500	500	500	500	500	450	1980	✓	✓
2975	6	500	500	500	500	500	450	2030	✓	✓
3000	6	500	500	500	500	500	500	2030	✓	✓
3025	6	500	500	500	500	500	500	2080	✓	✓
3050	6	525	525	500	500	500	500	2080	✓	✓
3075	6	525	525	500	500	500	500		✓	✓
3100	6	525	525	525	525	500	500		✓	✓
3125	6	525	525	525	525	500	500		✓	✓

## ISO45 & 20 OVERHEAD SECTIONAL GARAGE DOORS E<sup>®</sup> SPRING UP TO 3000MM WIDE X 2700MM HIGH

ISO45 sizes above 3000mm x 2700mm are supplied with front mount torsion spring as standard.  
All sectional doors including wicket doors are supplied with front mount torsion spring as standard.

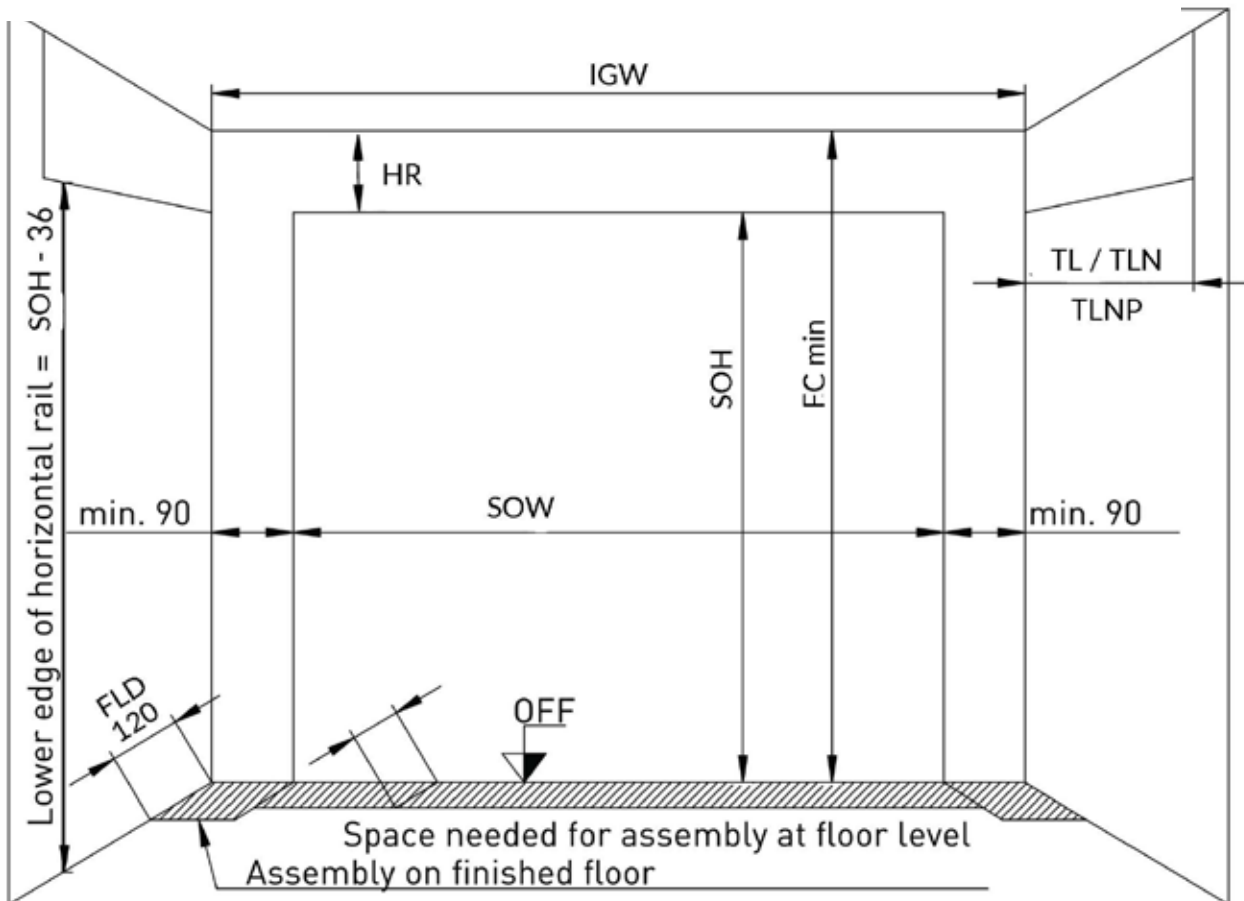

### Required Installation Dimensions

SOW	=	Structural Opening Width (Order Size)
SOH	=	Structural Opening Height (Order Size)
FC	=	Floor To Ceiling Height
IGW	=	Internal Garage Door Width
CPW	=	Clear Passage Width
CPH	=	Clear Passage Height
TL	=	Track Length
TLN	=	Track Length with Novomatic Operator
TLNP	=	Track Length with Novoport Operators
OFW	=	Overall Frame Width
OFH	=	Overall Frame Height
OFF	=	Upper-Edge Finished Floor
FLD	=	Frame Leg Depth

Please consult the "Coordinating widths and heights" chart or calculate the dimensions based on the drawings.  
If the structure does not have the required minimum dimensions, it can be compensated by fitting panels and profiles.  
All dimensions are in mm.

# ISO Sectional Garage Doors

## ISO45 & 20 OVERHEAD SECTIONAL GARAGE DOORS E<sup>®</sup> SPRING UP TO 3000MM WIDE X 2700MM HIGH

### FITTING BEHIND THE STRUCTURAL OPENING Top Down Elevation View

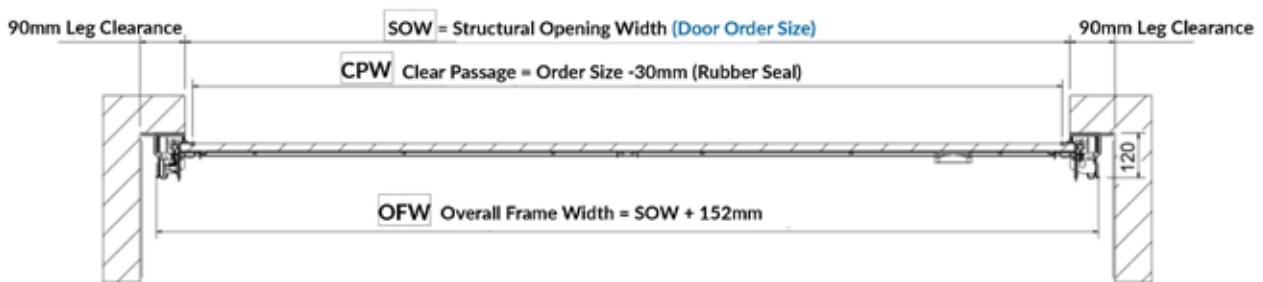

If you do not have a minimum of 90mm e.g. if you have 80mm each side take 10mm off per side totalling 20mm giving you Door Order Size

### FITTING WITHIN THE STRUCTURAL OPENING Top Down Elevation View

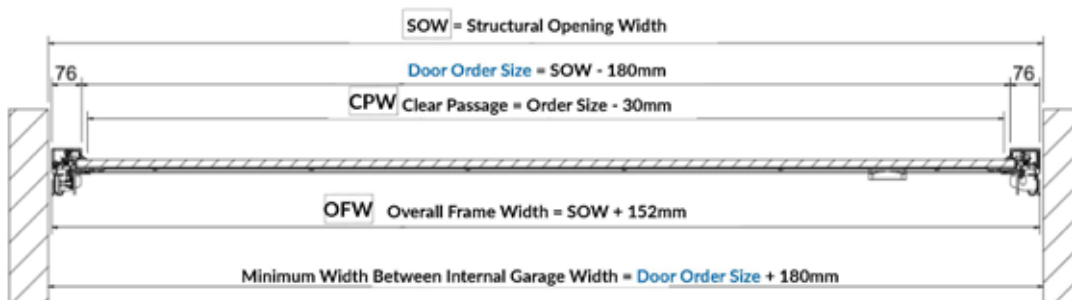

#### Ordering Information

To calculate the correct door order size to fit within a structural opening, deduct 180mm from the width and 120mm (rear mount) or 215mm (front mount) from the height. For behind the reveal fit calculate from drawings (using required headroom for front/rear mount).

## ISO45 & 20 OVERHEAD SECTIONAL GARAGE DOORS TENSION SPRING UP TO 3000MM WIDE X 2700MM HIGH Fitted Behind The Lintel (Side View) - Novoport Operator

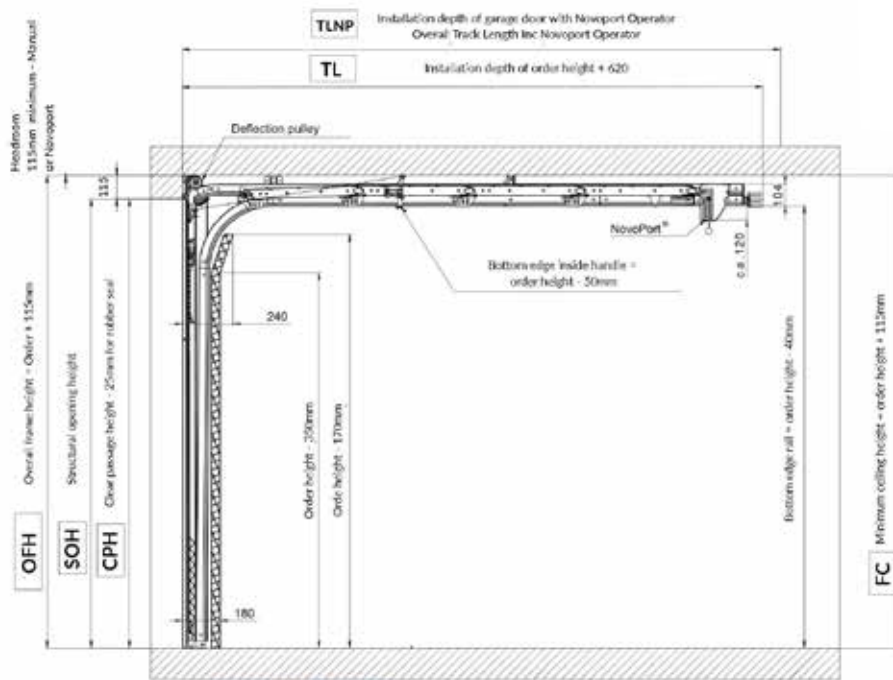

**Door Ordering Height = SOH With 115mm Headroom Required**

If you do not have 115mm headroom i.e 100mm headroom, take 15mm off the SOH to equal your **door ordering height**

If fitting under the lintel **Door Ordering Height = SOH - 115mm**



## Fitted Behind The Lintel (Side View) - Novomatic Operator

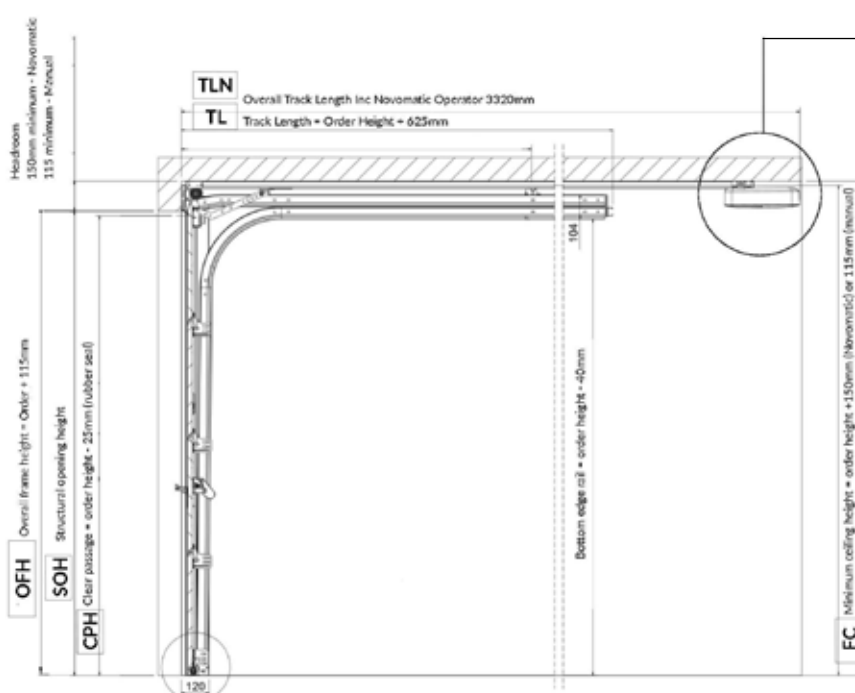

**Door Ordering Height = SOH With 115mm Headroom Required (Manual) 150mm (Novomatic)**

If you do not have 115mm headroom i.e 100mm headroom, take 15mm off the SOH to equal your **door ordering height**

If fitting under the lintel **Door Ordering Height = SOH - 150mm**

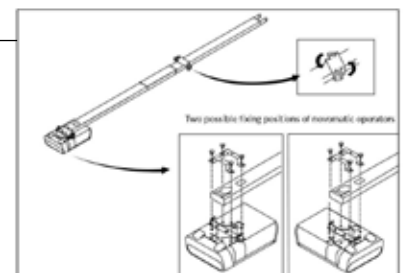

# ISO Sectional Garage Doors

## ISO45 OVERHEAD SECTIONAL GARAGE DOORS REAR MOUNTED TORSION SPRING DETAIL

### Fitted Behind The Lintel (Side View) - Novomatic Operator

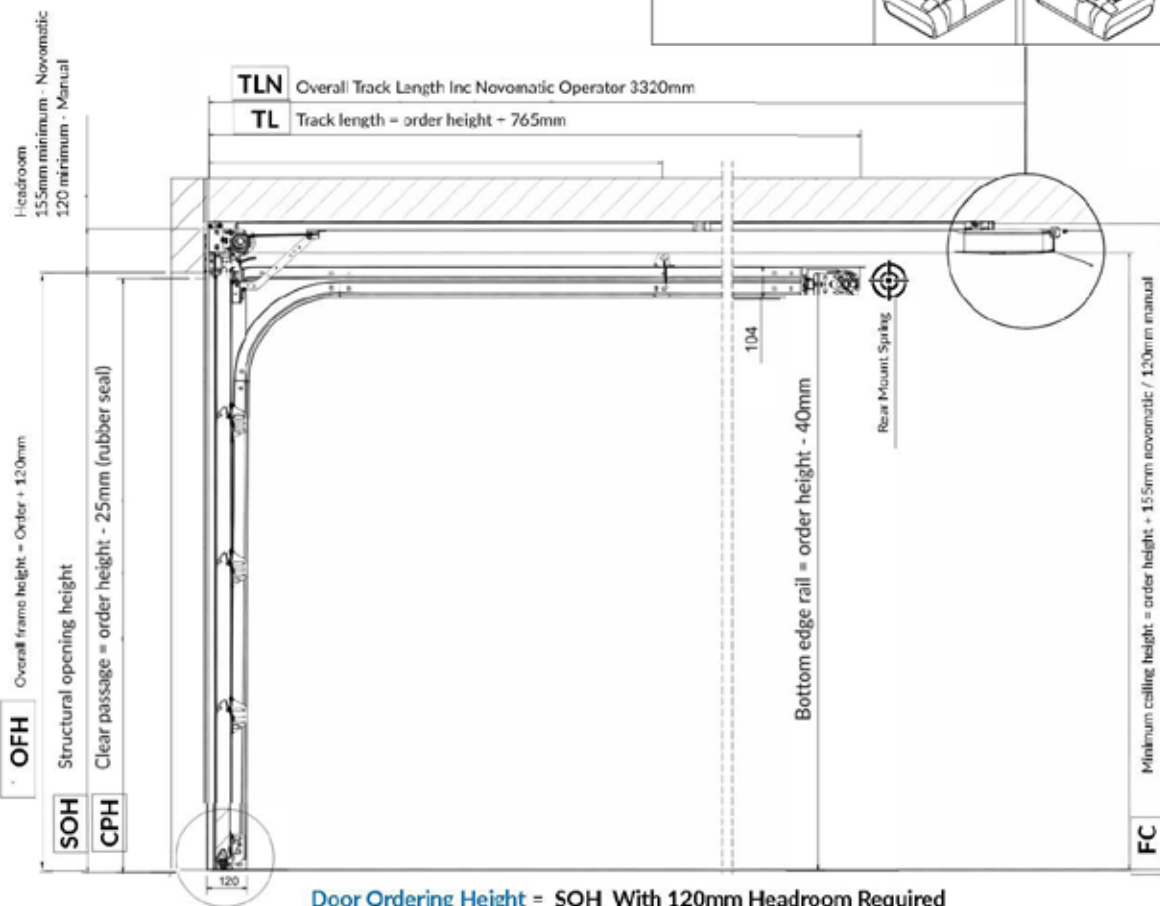
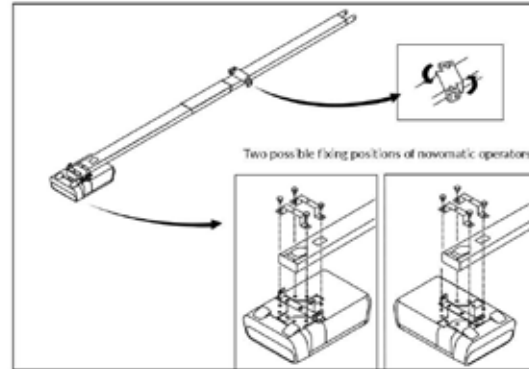

**Door Ordering Height = SOH With 120mm Headroom Required**

If you do not have 120mm headroom i.e 110mm headroom, take 10mm off the SOH to equal your **door ordering height**

If fitting under the lintel **Door Ordering Height = SOH - 120mm**

## ISO45 OVERHEAD SECTIONAL GARAGE DOORS FRONT MOUNTED TORSION SPRING DETAIL

Fitted Behind The Lintel (Side View) - Novomatic Operator

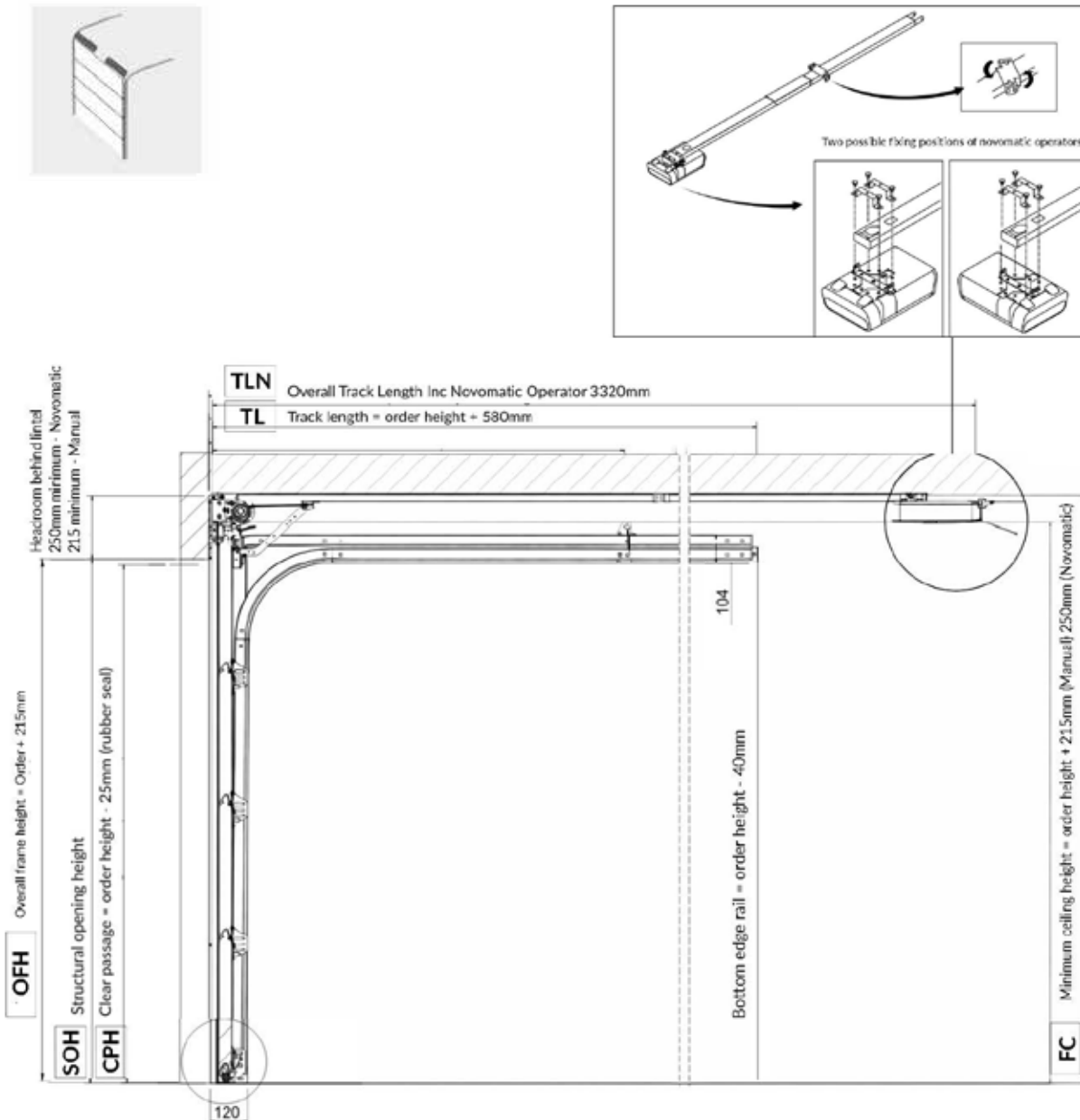

**Door Ordering Height** = SOH With 215mm Headroom Required (Manual) 250mm (Novomatic)

If you do not have 250mm headroom i.e 240mm headroom, take 10mm off the SOH to equal your **door ordering height**

# Sectional ISO EVO Matching Doors

## SECTIONAL ISO EVO MATCHING SIDE DOORS

Horizontal Cut (Installation behind the opening)

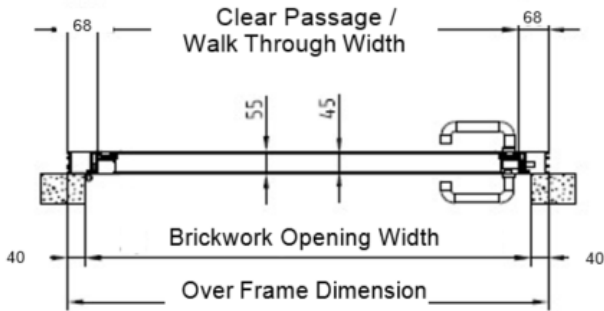

Horizontal Cut (Installation behind the opening)

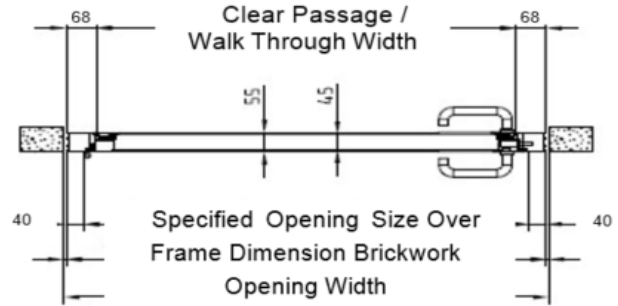

Vertical Cut (Installation behind the opening)

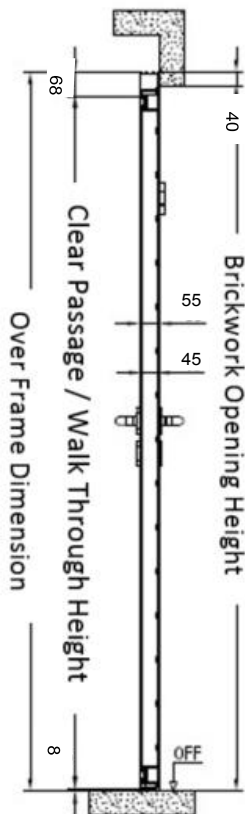

Vertical Cut (Installation in the opening)

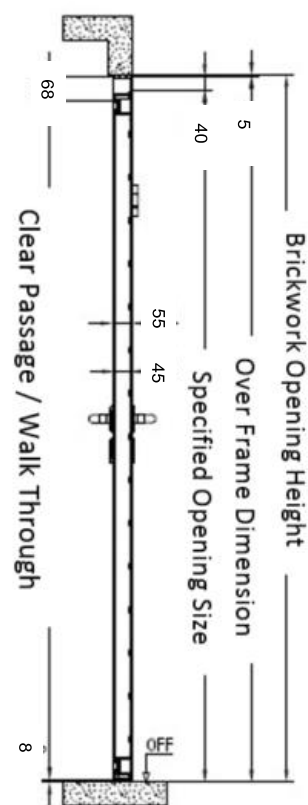

Note: The "Clear Passage / Walk through width" shown is the internal dimensions of the frame and does not allow for the thickness of the door panel when it is fully open, reducing the actual walk through with by the thickness of the door, 50mm.

## INSULATED ISO45 SECTIONAL WICKET DOORS

Size range for Sectional doors with pass door

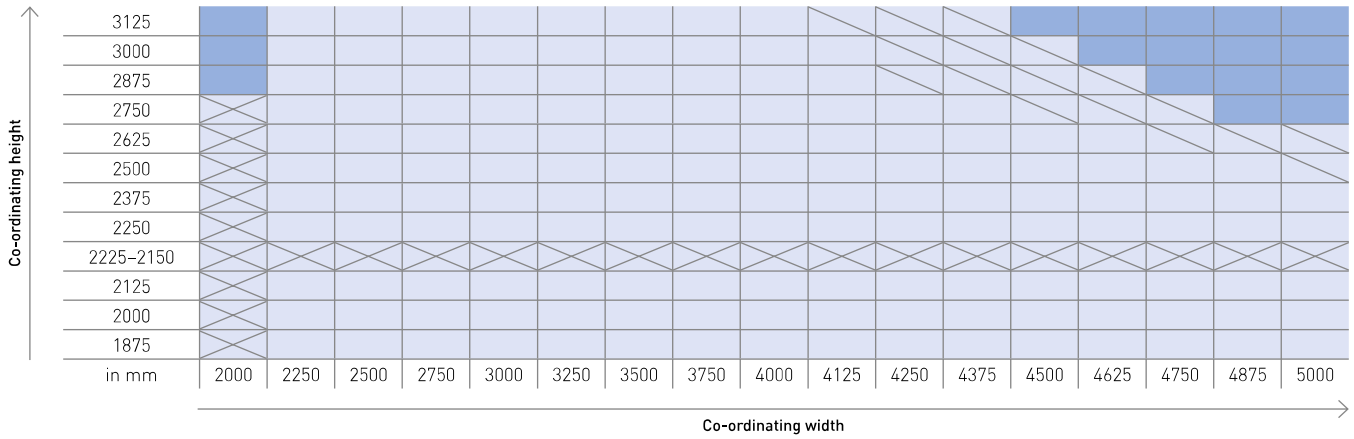

Light Blue: Size range of structural surfaces and smooth surfaces

Diagonal Lines: Size range only for structural surfaces

Cross-hatch: Raised panel not possible

Dark Blue: No pass door possible

Motive Horizontal rib: Heights of 2150 up to 2275, 2675, 2700 und 2725 not possible with a pass door

### Positioning of the Wicket Door



Symmetrical arrangement for garage door widths up to 3500mm.



Asymmetrical arrangement for garage door widths above 3500mm – optionally on the left with left hand hinge.



Asymmetrical arrangement for garage door widths above 3500mm – optionally on the right with right hand hinge.

# Novorol Insulated Roller Garage Doors

## NOVOROL INSULATED ROLLER DOORS

Door Height		Over Guide Width (mm)						Hang Down (mm)
		2000	2500	3000	4000	4500	5000	
Guide Widths	55mm Laths	65mm	65mm	65mm	N/A	N/A	N/A	50mm
	77mm Laths	70 or 90mm	70 or 90mm	70 or 90mm	90mm	90mm	90mm	50mm

**Box Sizes - Novorol 77** – Doors below 2300mm in height will be supplied with a 300mm box. Doors above 2300mm height will come supplied with a 360mm box. **Novorol 55** – Doors supplied with 205mm full box

### Fitting Within the Aperture / between the walls / between the reveal

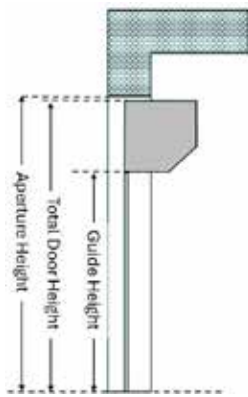

#### Guide Positioning

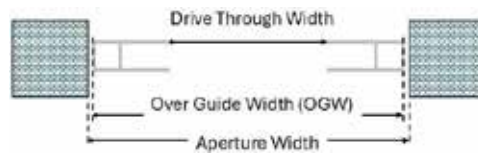

When installing doors where some / all of the Front 90 Deg Box is exposed it is recommended that the Rear Box is fitted to protect the Axle / Shaft Assembly and give added security.

### Fitting Behind the Aperture

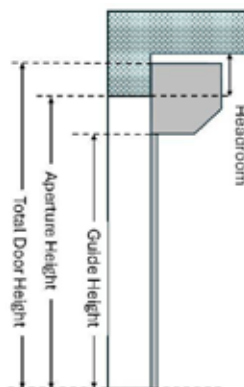
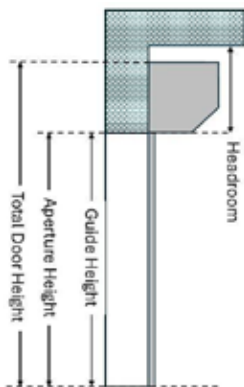

#### Guide Positioning

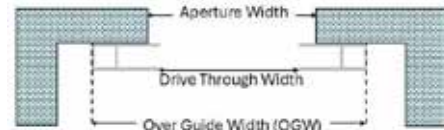

**Headroom**  
Ideally the Headroom available will be greater than the Box Height

### Typical Guide Fixing Methods

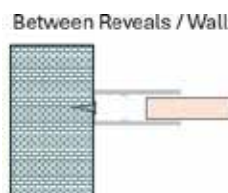
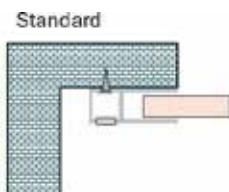

# Warranty & Maintenance



## Warranty & Maintenance

Our Steel, Roller and Sectional doors are supplied with a fully finished coating, which we guarantee for 5 years. Weathering and sun exposure can cause the finish to fade and that any fading will be minimal and uniform, providing the door is maintained in accordance with the care and maintenance advice.

**Please note:** due to the rolling action of a roller door, surface marking can be caused by security locks, dust and debris. This does not constitute as a product fault and performance is not affected in any way.

### Timber Garage Door Finish

Our timber doors are fully finished with a powder coated steel chassis and frame. Weathering and sun exposure can cause the finish to fade. We guarantee the finish on doors for 2 years and that any fading will be minimal and uniform, providing the door is maintained in accordance to the care and maintenance advice.

### What is covered?

Subject to the terms and conditions outlined in this document. Novoferm garage doors offer the warranty:

- 10 Years – Safe and reliable operation (for use up to 5 open/close cycles per day) – Up and Over, Side Hinged and Sectional Doors
- 10 years – Structural integrity of door panels – Up and Over, Side Hinged and Sectional Doors
- 10 years – Panel corrosion – Up and Over, Side Hinged and Sectional Doors
- 10 years – retractable, sectional and side hinged doors (2 years on canopy doors) on immovable frame parts
- 5 years – Finish – Up and Over, Side Hinged, Sectional Doors & Rollers
- 5 years – Motor/Control panels
- 2 years – movable and mechanical parts (including, but not limited to, springs, rollers wheels, locking points, rods/cables, barrel, locking mechanisms, locking straps and rings, safety brake)
- 2 years – remote controls and accessories (excluding batteries, bulbs and fuses)

### Care and maintenance

Timber is an organic substrate material with natural characteristics than can acclimatise itself, no matter the “species” to different environmental conditions prevailing in its localised “fixing or place”. Therefore, Novoferm accepts no liability or responsibility for variations occurring in our “Timber” products supplied, in any of the following descriptions i.e. “colour variations, movement either lateral or longitudinal, splitting, shakes, water damage ingress or exit, resin exudations or chemical spillages.

Conversely, Timber substrates can naturally expand and contract according to environmental conditions. Moisture content and humidity may open and close joints and some minor curvature may occur.

Any curvatures that occur however, will not affect the long term performance or life of this natural material.

**Please note:** Cedar is organically grown with natural colour and grain variations, which is a feature of Cedar. We make every effort to harmonise the effect by hand matching all components part used in manufacture.



Your steel door should be kept clean, with any stains removed as soon as possible. You should also ensure the door does not come into contact with any caustic or acidic substance, which could damage the door surface or structure. Your door should be cleaned thoroughly approximately every 2-3 months (in coastal areas or areas close to large bodies of saltwater, this should be done weekly) using warm water and a soft cloth or sponge. Allow to dry naturally. Never use detergent, abrasive, caustic, or solvent-based cleaners. Lubricate all springs, latches, wheel spindles, and pivot points using a light lubricating oil (e.g., 3-in-1). Take care not to allow oil to drip onto the face of the door. Ensure track runners are clean and free from obstacles at all times. Check moving parts for signs of wear. If any wear is detected, arrange for these to be replaced as soon as possible (failure to replace these parts can invalidate your warranty). Do not paint springs or any moving parts. For automated doors (retractable), do not operate the door when not within visual range.

### Corrosion

Doors situated in 'high corrosive' areas such as within 3 miles of the sea or a large body of saltwater are not covered for rust or corrosion of steel parts. Cleaning of the doors is especially important in these locations.

All Novoferm Garage Doors - What is not covered?

- Improper installation, negligent care and maintenance - doors which have not been maintained or had annual maintenance/servicing
- Improper initial and subsequent operation
- Negligent or wanton destruction
- External influences, such as: fire, water, salts, alkaline solutions, acids and any abnormal environmental influences, sunlight
- Mechanical damage, through improper transport and fitting, or through falling or hitting objects
- Repair by non-qualified persons
- Using non-Novoferm parts without the written approval of the manufacturer
- Removal of the product number, or making it unidentifiable
- Application of additional, non-approved weights or infills
- Failure to remove the protective film or packaging provided with the product, where applicable
- Failures caused by extreme or abnormal weather conditions

### Visual standards check

Timber is a natural material with defects, for example small knots, close, wide, or short grain, surface shakes, splits or grain lift. Although we endeavour to eliminate most of these phenomena in production, some may still appear after installation. Novoferm cannot be held responsible for any naturally occurring defect after installation.

Visual standard checks must be carried out prior to a warranty submission. This check should be carried out in natural daylight, not direct sunlight, standing at a distance of 3m from the door to view the overall appearance. Doors are acceptable if the following are not readily visible on the face of the door:

- Marks or distortion associated with the manufacturing process
- Minor indentations, marks, or scuffs on the surface
- Paint or Stain Blemishes

## Operators and Accessories Warranty

### Our promise:



During the warranty period, we undertake to rectify any defects to the Novoferm product, which can be proven to be attributed to a material or manufacturing defect.

We promise, at our discretion, to either exchange the defective merchandise or repair it. Replacement parts remain our property.

### Warranty Requirements

The warranty only covers manufacturing faults to the purchased garage door or garage door operator. Damage to these is not cover. You will be required to show a fully completed warranty service passport (service to be conducted by a qualified engineer annually), together with a receipt of purchase, which substantiates your right to claim under warranty. The finish on doors is exempt from the service requirements.

In the event of a claim, please contact the company that supplied/ installed the doors. They will raise the warranty on your behalf. During the claims process, a site inspection may be required. For this we will send an independent assessor. Should this inspection indicate the fault was not caused by a manufacturing defect, you will be liable for the cost of a non-warranty call out. The cost of the call out will be advised prior to the arranged visit.

Novoferm will not accept consequential costs for installation or deinstallation, inspection of parts, transport, and postage costs.

### What is covered?

Subject to the terms and conditions outlined in this document. Operators and accessories offer the following warranty:

- 5 years – All control panels
- 2 years- all remote control parts and accessories (excluding batteries, bulbs and fuses)

### What is not covered?

- Improper installation, negligent care and maintenance.
- Improper initial and subsequent operation
- Negligent or wanton destruction.
- External influences, such as: fire, water, salts, alkaline solutions, acids and any abnormal environmental influences.
- Mechanical damage, through improper transport and fitting, or through falling or hitting objects.
- Repair by non-qualified persons.
- Using non-Novoferm parts without the written approval of the manufacturer.
- Removal of the product number, or making it unidentifiable.
- Operators used upon a door which exceeds rated lifting capacities.
- Failure to remove the protective film or packaging provided with the product, where applicable.
- Failures caused by extreme or abnormal weather conditions.



*Intelligent Door Solutions*



V: 05.2026.1

**Call Us Now +44 (1582) 563777**

**Opening times**  
8.30am - 5.00pm  
Monday to Friday

Novoferm UK Ltd  
Unit 5 - 9 North Luton Industrial Estate  
Sedgwick Road  
Luton  
LU4 9DT  
E: [customerservice@novoferm.co.uk](mailto:customerservice@novoferm.co.uk)  
[www.novoferm.co.uk](http://www.novoferm.co.uk)